



CENTURY 41
AUTOPILOT
&
CENTURY 41
FLIGHT DIRECTOR/AUTOPILOT
PILOT'S OPERATING HANDBOOK

JANUARY 1985
68S803

TABLE OF CONTENTS

REVISION LOG	
FORWARD.....	4
FEATURES	6
Roll Axis and Pitch Axis	7
C41 Operating Controls	8
Master Disconnect/Trim Interrupt	10
Lateral Operating Modes	12
Pitch Operating Modes	15
Review of Interlocks and Failure Warnings.	18
Electronic Rudder Trim (Optional).....	19
Yaw Damper System (Optional)	20
Directional Gyro.....	21
C41 Flight Director Steering Horizon.....	24
C41 Flight Director Steering Horizon Two Cue (Optional)....	26
C41 Flight Director Steering Horizon Two Cue(4")(Optional)	27
NSD-360A and Other Compass Systems	30
C41 Operating Techniques	34
Localizer (LOC) Approach	35
Glideslope (GS) Automatic Arm and Couple	41
Localizer Back Course (LOC BC).....	43
VOR Approach.....	47
VOR Navigation	53
Maintenance.....	57
Emergency Operation	58
Product Improvements.....	59
Limited Warranty Century Flight Systems Autopilot.....	60

LOG OF REVISIONS

JANUARY 1985---ORIGINAL

FOREWORD

The Century Flight Systems Century 41 Autopilot is an advanced General Aviation Flight control System utilizing "State of the Art" electronic techniques.

In this handbook we have detailed the features, functions, and general operating instructions of the Century 41 System.

May we suggest that you do two things:

1. Read this handbook and your Airplane Flight Manual Supplement. This handbook presents general operating procedures. Each aircraft installation has an Airplane Flight Manual Supplement or Autopilot Handbook that contains FAA approved flight procedures and operation limitations in that particular model aircraft. The appropriate AFM Supplement is a document which must be aboard U. S. Registered Aircraft with the autopilot installed.
2. Spend some VFR time with the equipment to become familiar with its operation so that you may have the full benefit of its capabilities.



THE CENTURY 41 FLIGHT DIRECTOR/AUTOPILOT

FEATURES

The Century 41 Autopilot

This Autopilot only version uses a standard artificial horizon in combination with a directional gyro (DG) or an NSD-360A Horizontal Situation Indicator (HSI). It may optionally use other compatible heading systems.

The Century 41 Flight Director/Autopilot

When computed steering information is displayed on the horizon the system becomes a Flight Director. The three steering horizons presently used in the Century 41, are as follows:

1. 3-inch Single Cue (52C77).
2. 3-inch Two Cue (52D177).
3. 4-inch Two Cue (Cross Pointer) with raw data Glideslope and Localizer (52D178).

Both versions of the Century 41 are basically the same and the autopilot only version can be converted to a Flight Director by the addition of one of the above steering horizons. Either version may incorporate an optional Century Yaw Damper.

An outstanding feature of the Century 41 is that it has a rate based inner loop for short term dynamics. This means that rate information is derived from the horizon so that motion about the roll and pitch axis is programmed to occur at a rate approximate to the activity. Examples of controlled rate motion are as follows:

ROLL AXIS:

Heading Command - Roll at 5° per second diminishing near bank limit.

Navigation Soft Mode - Roll at 2.5° per second to reduce bank limit (8°).

Gust Disturbances - Resisted by instantaneous servo command.

PITCH AXIS

Command Attitude - 0.7° per second attitude change.

Command Altitude Change - 0.7° per second attitude change until reaching 500 feet per minute climb or descent.

Gust Recovery - Maximum rate consistent with passenger comfort.

Maximum System Capability - 2.4° per second.

CENTURY 41 OPERATING CONTROLS

The Mode Programmer push button switch placards are lighted and dimming is provided by the control panel light dimmer switch.

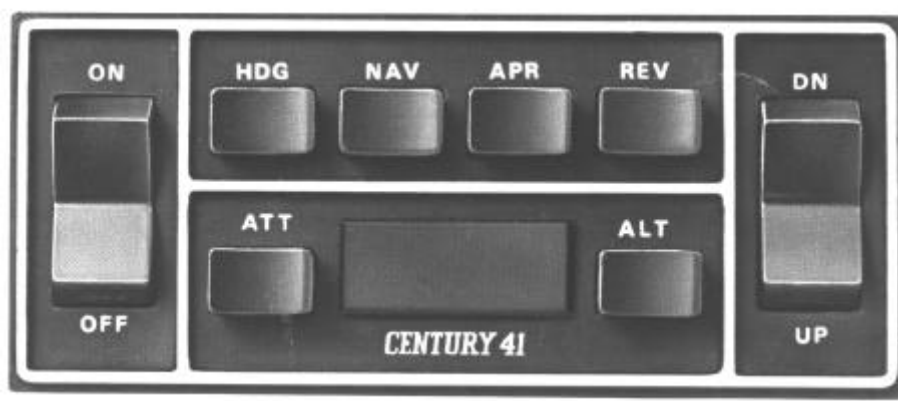

The Mode Annunciator light intensity is controlled automatically by a self-contained ambient light level sensor; this feature provides optimum Mode Annunciator light level for all cockpit lighting conditions. The Century 41 Autopilot is activated with the Aircraft Master switch and operates in a low power state until the Flight Director display and/or autopilot operation is desired. Mode selection is made by pushing the desired mode switch on the Mode Programmer. The selected mode will be illuminated on the Mode Annunciator.

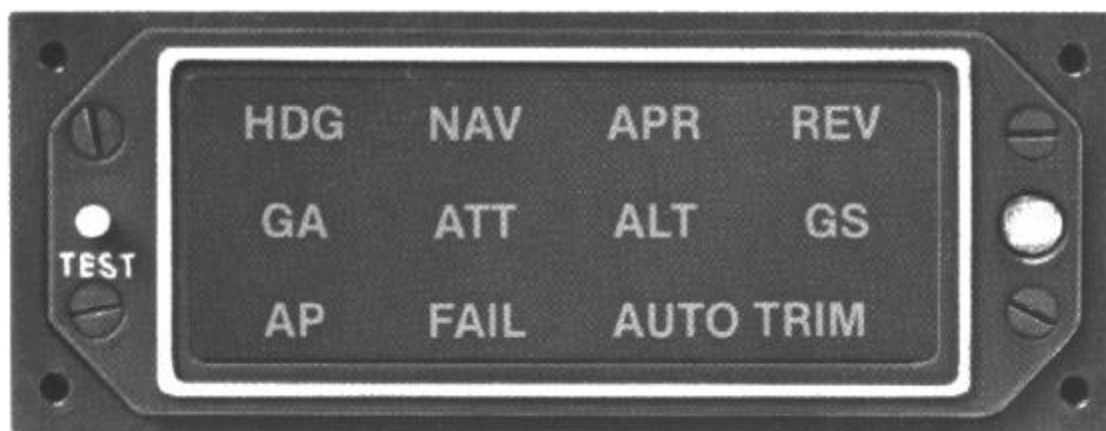

A separate Trim Master switch is located on the Control Panel. Auto Trim Function is activated by the Autopilot Engage switch.

A Go-Around switch is located on the left horn of the pilot's control wheel or on the left throttle arm.



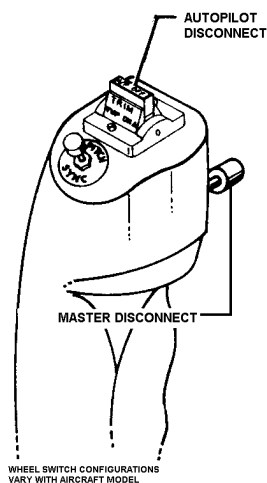

AUTOPILOT ON - OFF - Autopilot engage is accomplished by pressing the momentary ON-OFF rocker switch on the left side of the Programmer. When operating as an autopilot only version or as a Flight Director with the steering bars stowed., the Autopilot will engage in the HDG and ATT modes with synchronization to the existing aircraft pitch attitude. In the Flight Director version (steering bars in view), the Autopilot will engage in the previously programmed lateral and pitch modes.

The HDG mode the aircraft will track the heading selected on the DG or HSI. In NAV, APR or REV modes the aircraft will intercept and track any properly programmed radio-defined course. Instructions for proper radio set up in these modes are included in this manual.

In ATT mode the autopilot will synchronize to the aircraft pitch attitude upon engagement.

In ALT mode the aircraft will synchronize to the pressure altitude present at the time of engagement.

The autopilot may be disengaged by pressing the momentary ON-OFF rocker switch on the programmer; by pressing the AP DISC. Switch on the control wheel trim switch; by pressing the master disconnect switch, if present, on the control wheel; or by interrupting power at the Aircraft Master switch. Disengagement causes the AP annunciator to flash for 5 seconds.

MANUAL ELECTRIC TRIM - With the Aircraft and Trim Master switches on, a manually operated electric trim function is activated by the control wheel trim switch. This switch serves a dual function:

1. Disengage the autopilot.
2. Activate manual electric trim.

Pressing down on the center rocker bar causes autopilot disengagement. This action also activates trim enabling power. Movement of the bar forward and aft causes the trim to run in a corresponding down-up direction.

MASTER DISCONNECT TRIM INTERRUPT

Many Century 41 autopilots incorporate an additional switch on the control wheel (usually a red button). Pressing this button will disconnect the Century 41, the Yaw Damper, (if installed), and will interrupt the operation of the Trim System. Release of the button will restore power to the Trim System but AFCS re-engagement is necessary to resume automatic flight.

AUTO TRIM - The Century 41 Autopilot is equipped with automatic pitch trim. When the Trim Master switch is on, Auto Trim is activated by engaging the autopilot. If all is normal no indication of Auto Trim will occur on the Mode Annunciator. Should the Trim Master switch be turned off or if trim power failure should occur while the autopilot is engaged, AUTO TRIM will flash on the Mode Annunciator.

The Auto Trim is fail safe in design. Should a trim malfunction occur (other than power failure), FAIL and AUTO TRIM will flash on the Mode Annunciator and the trim servo will disengage.

PREFLIGHT AUTOMATIC TEST SEQUENCE

+

The Century 41 is equipped with a comprehensive automated self-test program which, when activated on the ground prior to autopilot engagement will test the following:

1. Validity of gyro excitation monitor.
2. Automatic trim failure monitor circuits.
3. All Mode Annunciator indicators.

COMMAND TRIM - To be performed before first flight of each day.

PROCEDURE:

1. Set Trim Master switch to ON.
2. Using the control wheel trim switch, verify normal trim system up and down operation.
3. Depress and hold center rocker bar on control wheel trim switch. Observe that trim system does not operate.
4. Release center rocker bar and move the rocker bar forward and aft. Observe that trim system does not operate with any single action.

CAUTION

Any failure of the above procedure indicates that a failure exists in the system and the Command Trim shall not be operated until the failure has been identified and corrected.

AUTOPILOT/AUTO TRIM - To be performed before first flight each day.

PROCEDURE:

1. Verify Trim Master Switch is ON and that the autopilot is disengaged.
2. Press and hold TEST push button switch on Mode Annunciator. Verify the following sequence, (each indication will last approximately two seconds).
 - a. All annunciators illuminate with FAIL and AP flashing.
 - b. AUTO TRIM flashes, goes steady then flashes.
 - c. All annunciators illuminate steady.
 - d. After three to five seconds, AUTO TRIM and FAIL will flash for third time.
3. With TEST push button switch still depressed, use the control wheel trim switch to verify trim system will not operate in either up or down direction.
4. Release the TEST push button switch. All annunciators except HDG and ATT extinguish.

CAUTION

Any deviation of the above sequence indicates a failure exists in either the primary system or in the monitor circuits and trim system shall not be operated until the failure has been identified and corrected.

LATERAL OPERATING MODES

HEADING - In HDG mode the autopilot will capture and hold the heading selected on the DG or HIS. HDG annunciator will illuminate.

HDG

NAVIGATION - In NAV mode the autopilot has an automatic 45° VOR-LOC intercept angle and selected angle intercepts when equipped with the NSD-360A or other HIS. NAV annunciator will illuminate.

NAV

When executing an intercept, the rate at which the aircraft is closing upon the selected radio-defined course is determined by the computer and at the proper time an on-course turn is initiated. After course interception, "window logic" circuits observe that the course error is within $\pm 11^\circ$ and the radio deviation is less than $\pm 10\%$ of full scale. This logic initiates crosswind correction, radio gain reduction, lowers the roll rate to 2.5° per second and limits bank angles to 8° to produce an automatic "soft" navigation mode when tracking VOR. The system will remain in soft mode during station passage. However, if a new course which requires re-intercept is selected, the soft mode will unlock and the intercept sequence will reoccur.

NOTES

The NAV mode should be used when executing a holding pattern on the localizer to prevent automatic glideslope coupling.

When radio receiver is tuned to a localizer frequency, the GS coupler will operate with localizer (APR) dynamics in the NAV mode.

HEADING SYSTEMS

In systems equipped with DG the autopilot heading bug must be set to match the selected VOR radial.

In systems equipped with an NSD-360A or other HIS instrument, the heading bug is disabled when the NAV, APR or REV modes. In these modes the azimuth information to the autopilot is provided by the radio course pointer.

NOTES

In systems equipped with an NSD-360A or other HSI always set the radio course pointer to the Front Course Inbound Heading when operating in the APR or REV modes.

In systems equipped with a DG, always set the heading bug to the final approach heading to the airport.

See section on operating techniques for additional operating instructions for the NSD-360A.



In systems equipped with an NSD-360A or other HSI, a selected intercept angle function is available while operating in the NAV, APR and REV modes.

Selected intercept is initiated by performing the following steps:

1. While operating in the HDG mode, set the course pointer to the desired radial.
2. Set the heading bug on the NSD to the desired intercept heading.
3. Press the HDG and NAV, HDG, and APR or HDG and REV mode buttons simultaneously.



OR



OR



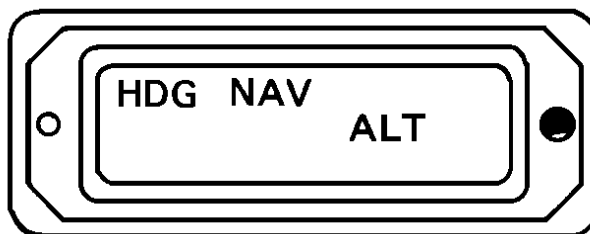

Both HDG and the selected lateral mode will now illuminate on the annunciator. As the aircraft begins its on course turn, the HDG annunciator will extinguish indicating that the system has captured the radio signal and is now receiving azimuth input from the course pointer.

NOTE

If valid radio signal is lost after initiating a selected angle intercept, the applicable navigation mode annunciator will flash the autopilot will remain in the HDG mode.

APPROACH - The APR mode provides automatic 45° VOR-LOC intercept angle and selected angle intercepts when the system is equipped with an NSD-360A or other HSI. The intercept, crosswind and tracking sequences are similar to those described in the NAV mode of operation except that softening is delayed for 90 seconds after intercept and bank angle limits are reduced to 12° at 3.6° per second maximum roll rate. The APR mode has additional enabling logic for the automatic glideslope arm, capture and track sequence and must be used on ILS approaches.

APR



REVERSE (Back Course) - The REV mode is for use in tracking the localizer back course inbound and front course Outboard.

REV

45° automatic intercepts, selected angle intercepts, crosswind correction and tracking are as described in the APR mode except that response to radio signals are reversed.



NOTES

When using an NSD-360A or other HSI, always set the course pointer to the inbound front course localizer heading.

When using a DG, always set the heading bug to the final approach heading to the airport.

PITCH OPERATING MODES

ALTITUDE - **ALT** mode will cause the aircraft to maintain the pressure altitude present at the time of ALT engagement or at the time of autopilot engagement if ALT has already been selected.

ALT

ALT may be engaged at maximum rate of climb or descent, but for passenger comfort, rate of climb or descent should be reduced to 1,000 feet per minute prior to ALT engagement. Corrections. To ALT may be made as described in paragraph on the Pitch Data Modifier.



ATTITUDE - ATT mode places pitch command with the pitch data modifier. Pitch is always synchronized to the existing aircraft attitude. When engaging the autopilot in ATT mode or when transferring the system to ATT from ALT or Go-Around modes the aircraft will maintain its existing attitude.



PITCH DATA MODIFIER - The pitch data modifier is a momentary type switch, located on the right side of the Mode Programmer, used to modify either the selected altitude or attitude.

When the autopilot is engaged in ATT mode, holding the pitch data modifier either up or down will cause the aircraft to rotate at 0.7° per second until a vertical speed of 500 feet per minute is reached. Upon release of the modifier, the system will synchronize to the attitude present at the moment of release.

When the autopilot is engaged in ALT mode, holding the Pitch Data Modifier either up or down will cause the aircraft attitude to change at 0.7° per second until a vertical speed of 500 feet per minute is reached. Upon release of the modifier, the system will synchronize to the altitude present at the moment of release.

GLIDESLOPE COUPLING - In the presence of selected APR mode only and other enabling logic, the glideslope function is fully automatic. Therefore, no GS engage switch is used. Glideslope may be entered from either ATT or ALT mode, from either above or below the glideslope.

Capture of the glideslope depends upon satisfying conditions which will complete the arming sequence. After arming, capture will occur just before glideslope interception so as to rotate smoothly to interception. This “anticipative capture” point is determined by the rate of closure satisfying a computer equation. In order for the glideslope to arm, the following conditions must exist simultaneously:

1. No 1 NAV radio channeled to a localizer frequency.
2. Localizer deviation must be less than 80% of full scale.
3. A valid localizer signal (no flag).
4. A valid glideslope signal (no flag).
5. APR mode selected.

When these conditions are met the GS Annunciator will illuminate in conjunction with the active pitch mode light indicating glideslope is armed. When “anticipative capturing” occurs, the active pitch mode light will go out leaving only the illuminated GS annunciator to indicate that transition to the glideslope signal has occurred. The GS mode may be deactivated by selection of any other pitch mode (**ALT, ATT, GA**) but automatic recapture of the glideslope may occur in ALT or ATT modes.

NOTES

The NAV mode should be used when executing a holding pattern on the localizer to prevent automatic glideslope coupling.

When radio receiver is tuned to a localizer frequency, the GS coupler will operate with localizer (APR) dynamics in the NAV mode.



GO-AROUND - A separate go-around mode switch is located on the throttle or control wheel. Activation of this mode results in a pitch up attitude to best single engine rate of climb. With two engines operating it will result in an approximate cruise climb. Activation of the GA mode does not alter the lateral mode.

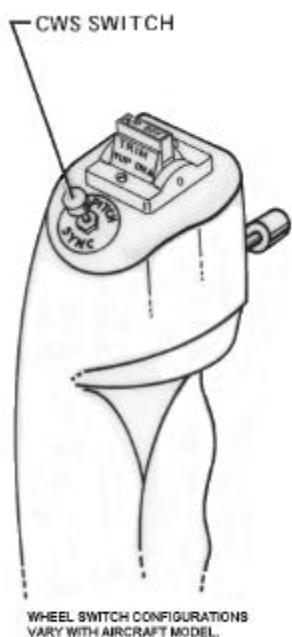

CWS MODE - The system is equipped with pitch sync switch located on the left horn of the pilot's control wheel. When depressed this switch will disengage the roll and pitch servos to allow manual maneuvering.

When released the system will re-engage in the lateral (roll) mode previously in use.

If the pitch is in ALT mode the system will synchronize to the pressure altitude present upon release of the CWS switch.

If the pitch axis is in ATT mode the system will synchronize to the attitude present at the time of release.

REVIEW OF INTERLOCKS AND FAILURE WARNINGS

The Century 41 System includes a number of automatic interlocks that will prevent system operation or individual mode operation if the input information is not valid or if other prerequisite conditions do not exist. In addition to the interlocks, the system will annunciate various failure conditions as advisory information for the pilot. Following is a brief description of interlocks and warnings provided.

INTERLOCKS

Autopilot engagement is inhibited unless valid gyro excitation is being provided by the system.

Selection of ALT mode is inhibited if the system altitude information is unreliable or if the entire system has not been powered for a time sufficient to allow temperature stabilization, usually 2 to 6 minutes depending on ambient temperature.

If the navigation information becomes invalid during selected angle intercepts the appropriate NAV/APR/REV annunciator will flash and automatic mode switching from HDG to the armed navigation mode will be inhibited.

WARNINGS

LOW VOLTAGE - When the aircraft bus voltage provided the system falls below the minimum required for reliable system function, any mode annunciator not already illuminated will flash.

ATTITUDE GYRO EXCITATION - Absence of valid gyro excitation will cause the autopilot to disengage and the AP and FAIL annunciators to flash. The autopilot cannot be re-engaged until this condition is corrected.

AP DISENGAGEMENT - Anytime the autopilot is disengaged the AP annunciator will flash for approximately 5.0 seconds, then remain off.

NAVIGATION INFORMATION INVALID - The appropriate navigation mode annunciator will flash when selected and invalid navigation signals are present (NAV Flag in view).

GLIDESLOPE INFORMATION INVALID - The GS annunciator will flash when glideslope information is invalid or any other GS Arming condition is lost (GS flag in view) after glideslope capture. If valid glideslope information or any other GS Arming condition is not available during the arming sequence, the system will not arm and glideslope capture will not occur.

AUTO TRIM FAILURE - When the autopilot is engaged and the auto trim malfunction monitor detects a trim failure, the trim servo engage solenoid is deactivated and the AUTO TRIM and FAIL annunciators will flash.

When the autopilot is engaged and trim system power is available, the Auto Trim is normally on without annunciation. If trim power is lost during autopilot operation the AUTO TRIM annunciator will flash.

ELECTRONIC RUDDER TRIM (Optional)

An optional automatic Rudder Trim System is available for some aircraft models for use with the Yaw Damper System. The function of the Rudder Trim System is to adjust the rudder trim tab to relieve rudder forces. The System is interlocked with the main Autopilot and the Yaw Damper so that both must be on for the rudder trim to be operational.

YAW DAMPER SYSTEM (Optional)

The Century Flight Systems Yaw Damper System is a frequently installed option with the Century 41. The system has only one control - the ON-OFF Push Button. The system is an independent subsystem that may be used with or without the Century 41.

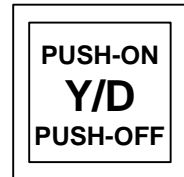

For pilot assistance and passenger comfort, its function is to add additional stability to the yaw axis of the aircraft and minimize any tendency to hunt or dutch roll in the aircraft. In addition, the Yaw Damper incorporates an “electronic ball” to assist in coordinating turns and trimming the aircraft under conditions of asymmetric power. The Yaw Damper does not ordinarily compensate for rudder trim variations with speed changes and therefore may “bump” the rudder controls slightly when engaged or disengaged at speeds other than that for which it is adjusted.

The Yaw Damper is engaged by pressing the ON-OFF Push Button. It is disengaged by pressing the ON-OFF Push Button or by pressing the Master Autopilot Disconnect-Trim Interrupt Button.

The Yaw Damper switch is a lighted annunciator type switch which is connected to the panel lamp rheostat controlling the light intensity in the area of installation. On some installations, the light intensity for day operations is low under some ambient light conditions. For this reason, the knob edge is engraved with a black index line that is in view when the system is “OFF” and hidden when the system is “ON”.

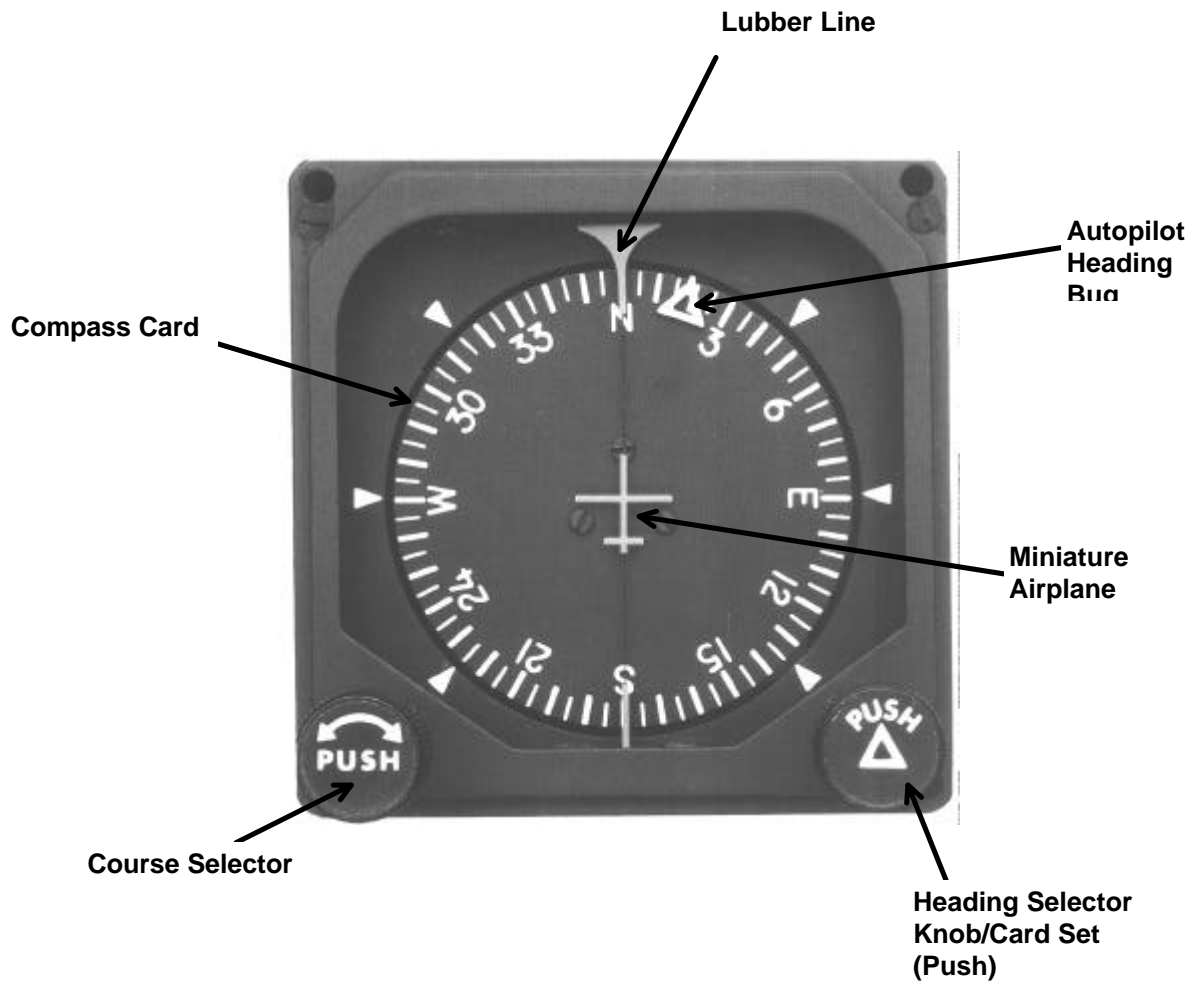

DIRECTIONAL GYRO

DIRECTIONAL GYRO

The Heading Selector DG replaces the standard directional gyro and provides a fully visible heading indicator around the normal DG opening. The DG dial is marked in 5° intervals and numbered each 30° around its azimuth. A center index is provided at the tip to align selected headings. Additional indices are located each 45° to facilitate rapid turn selection without mental arithmetic. Any heading may be selected, either before or after engagement, and turns up to 180° may be programmed directly, either right or left. If the heading indicator is rotated beyond 180° from the DG card heading, the heading selector will command a reversal in bank to reach the resultant selected heading in the shortest direction.

The DG card is normally set to the magnetic compass with the caging knob on the left in the usual fashion, while the heading selector indicator is rotated by the heading knob on the right. Direction of rotation of both the knob and indicator commands the same direction of turn.

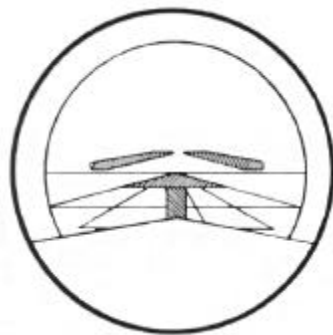
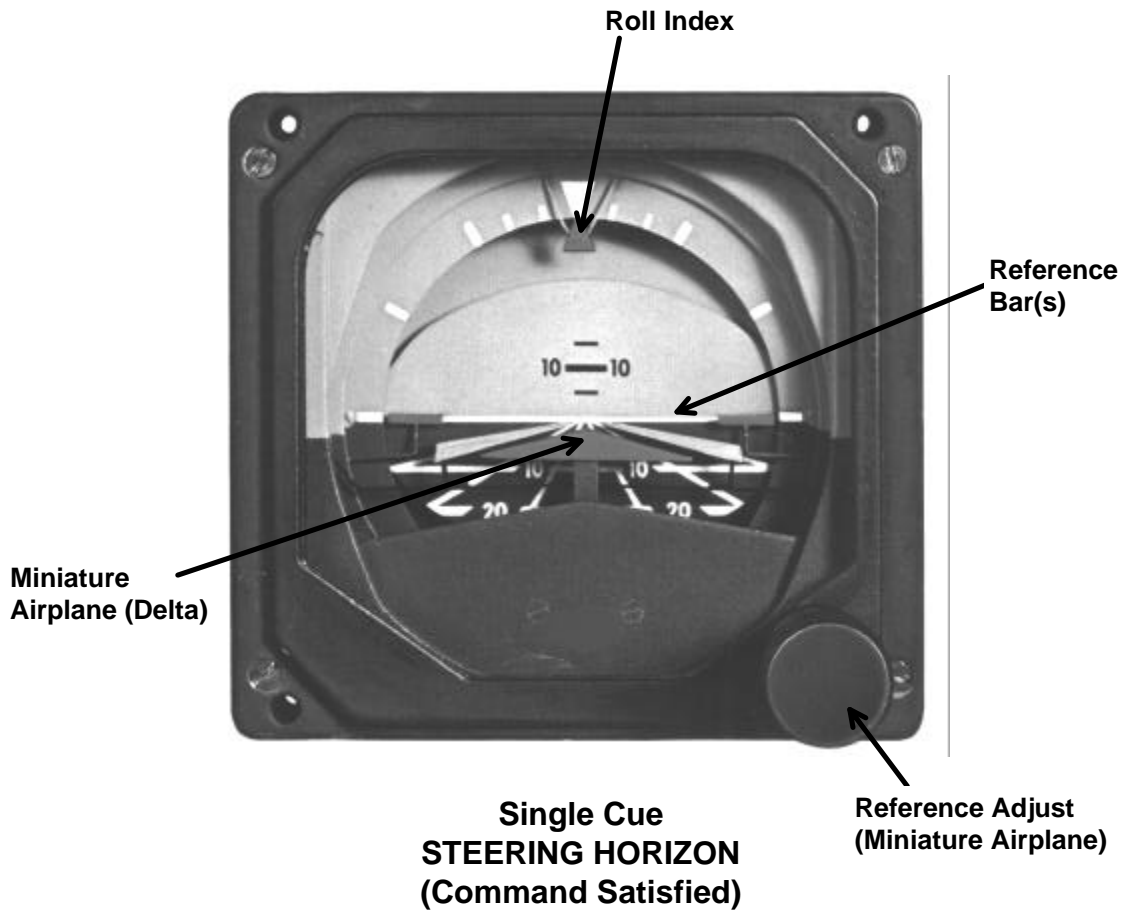

Fly Up

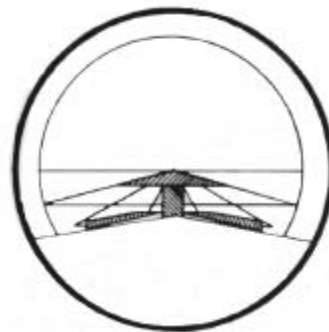

Fly Down

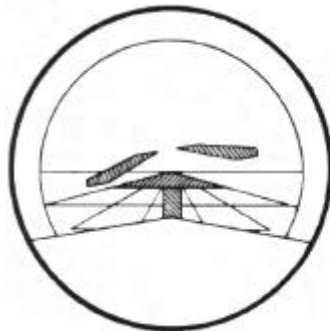

**Fly Left
(Fly Up)**

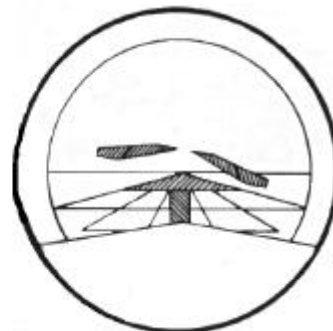

**Fly Right
(Fly Up)**

CENTURY 41 FLIGHT DIRECTOR STEERING HORIZON

Single Cue (Optional)

Addition of the Flight Director option to the Century 41 is accomplished by substituting the Steering Horizon (pictured previous page) for the Standard Artificial Horizon.

With the Steering Horizon installed, the pilot may choose to program a particular flight sequence and monitor autopilot maneuvering by observing the steering bar or he may turn the autopilot OFF and place himself in the control system loop by following commands of the steering bar. The great advantage of the Flight Director is that the computer observes many inputs, compares these inputs to the sequence programmed by the pilot and resolves differences into combinations of four commands: Fly Up, Fly Down, Fly Left and Fly Right. To accomplish the programmed maneuver, the pilot need only to “fly the miniature airplane (delta) into the ‘vee’ of the steering bar”. Pictured on the previous page is the steering horizon with significant parts labeled and illustrating Fly Up, Fly Down, Fly Left and Fly Right.

NOTES

The pilot should always keep in mind that the Steering Horizon displays COMPUTED DATA and will give a “command satisfied” indication if the pitch attitude and intercept heading are satisfactory for normal conditions.

The system cannot compensate for inadequate power or airspeed to accomplish the desired maneuver, therefore, a raw data display is mandatory with the Flight Director display so that the pilot is constantly presented with concise data on his heading and actual position on the Localizer, Glideslope and VOR Radial. For this reason, whenever the Steering Horizon is installed, the NSD-360A (described later) or similar horizontal situation indicator must also be installed.

CAUTION

Steering information is NOT disabled if NAV flags appear. The pilot should monitor the HSI to assure reliable NAV information is present.

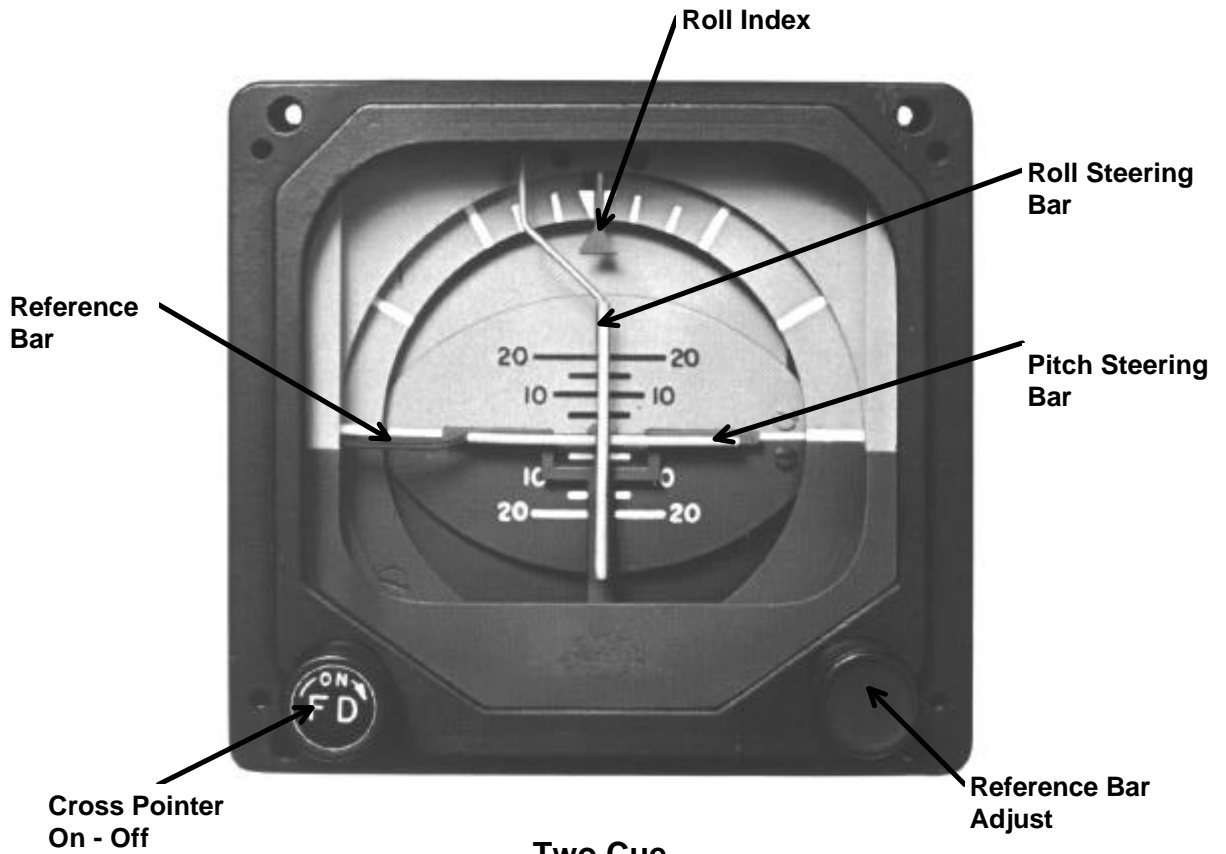

**Two Cue
STEERING HORIZON
(Fly Up - Fly Right)**

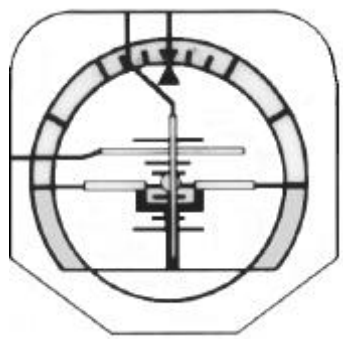

Fly Up

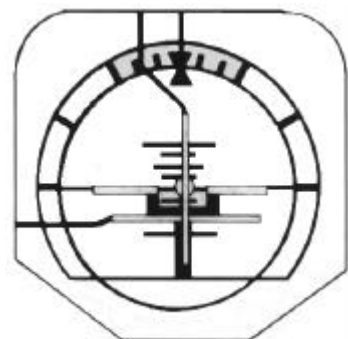

Fly Down

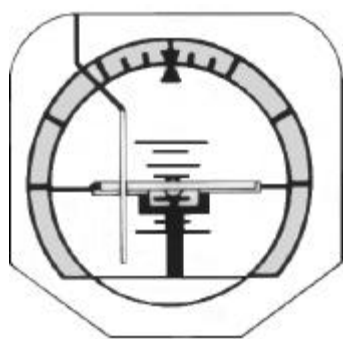

Fly Left

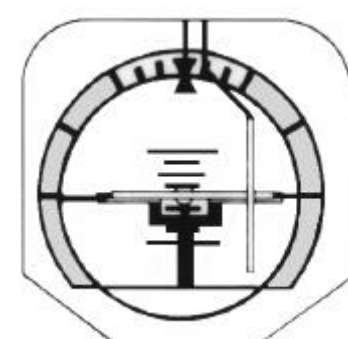

Fly Right

**CENTURY 41 FLIGHT DIRECTOR
STEERING HORIZON
Two Cue
(Optional)**

An optional Two Cue (cross pointer) Steering Horizon may also be used with the Century 41. With the Two Cue Steering Horizon (pictured at left) installed and turned "ON", the pilot may program a particular flight sequence and monitor autopilot maneuvers observing the pitch and roll steering bars. A command satisfied situation is indicated by a centering of the steering bars over the dot on the reference bar.

In addition, the pilot may manually execute the programmed flight sequence by turning the autopilot "OFF". By observing the commands of the steering bars and moving the controls to keep the bars centered, the programmed flight sequence will be executed.

NOTE

The Two Cue Steering Horizon is equipped with an "ON-OFF" switch to control the steering bar display. This FD ON-OFF control does not affect any other function.

CAUTION

Steering information is not disabled if NAV flags appear. The pilot should monitor the HSI to assure reliable NAV information is present.

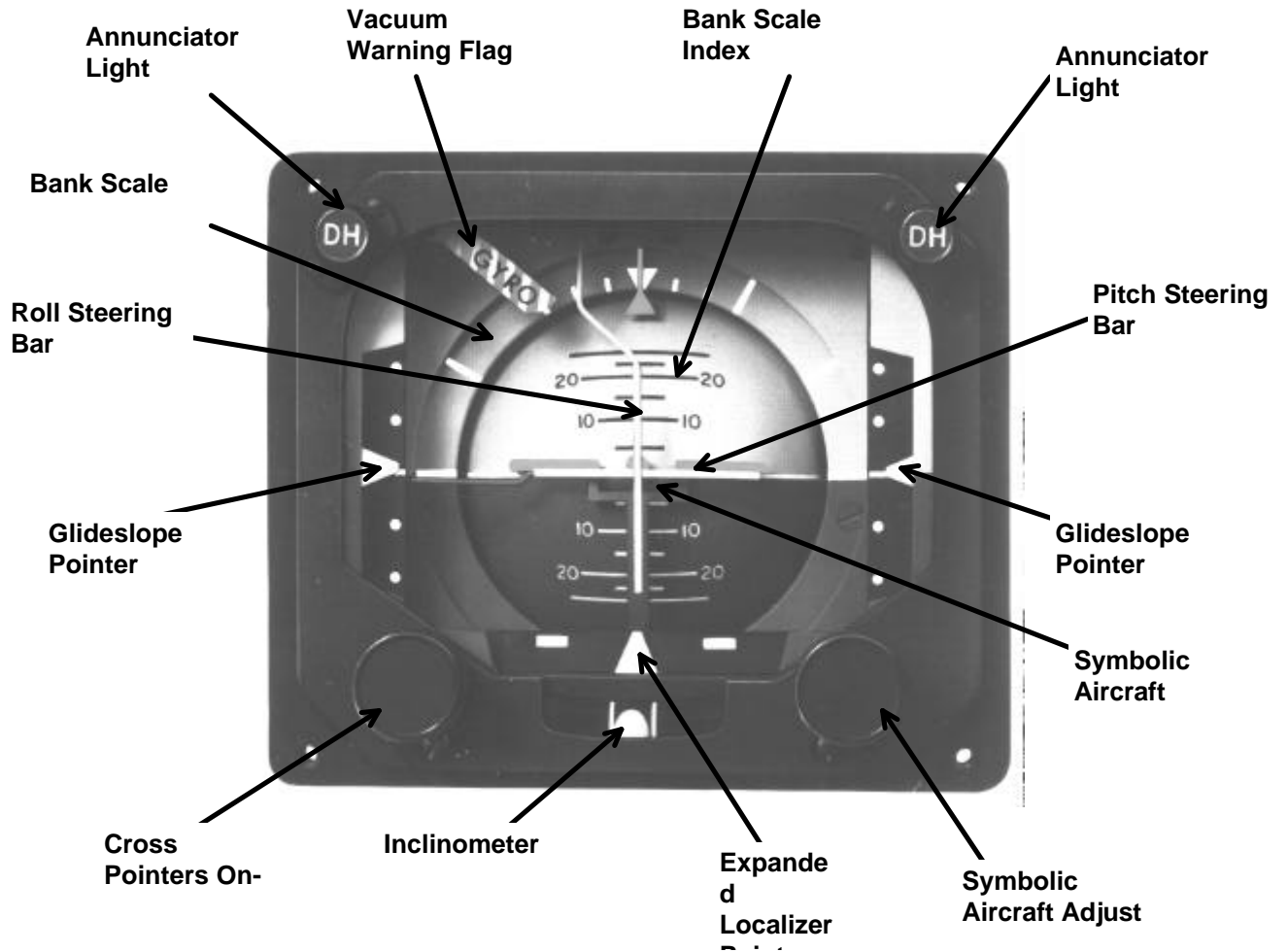

**Two Cue (4-Inch)
STEERING HORIZON
(Wings Level)**

**CENTURY 41 FLIGHT DIRECTOR
STEERING HORIZON
Two Cue (4-Inch)
(Optional)**

The optional Two Cue (cross pointer) Steering Horizon (pictured on previous page) is used with the Century 41 Flight Director. This Steering Horizon incorporates all of the features and functions of the Two Cue Steering Horizon.

In addition, this Steering Horizon provides a dual glideslope display; a 25% expanded localizer display (58° for full scale); a “slip/skid” inclinometer and two decision height annunciators. The glideslope and expanded localizer indicators repeat the raw data indications located in the HSI instrument and thus the pilot may observe both computed steering and raw data indications within a single instrument. The expanded localizer scale provides increased localizer sensitivity for extremely accurate localizer tracking information.

When the glideslope or localizer signals are not reliable the processed raw data display pointers in the Steering Horizon will be removed from view and the GS or NAV flag will appear on the HSI instrument. The computed steering information is not disabled when the NAV or GS signal is unreliable, therefore the pilot should monitor the raw data display to assure that the navigation information is reliable. During an instrument approach, if a significant disagreement is observed between the navigation position information and the computed steering display, a missed approach should be initiated immediately and the reason for the disagreement identified prior to completing the approach.

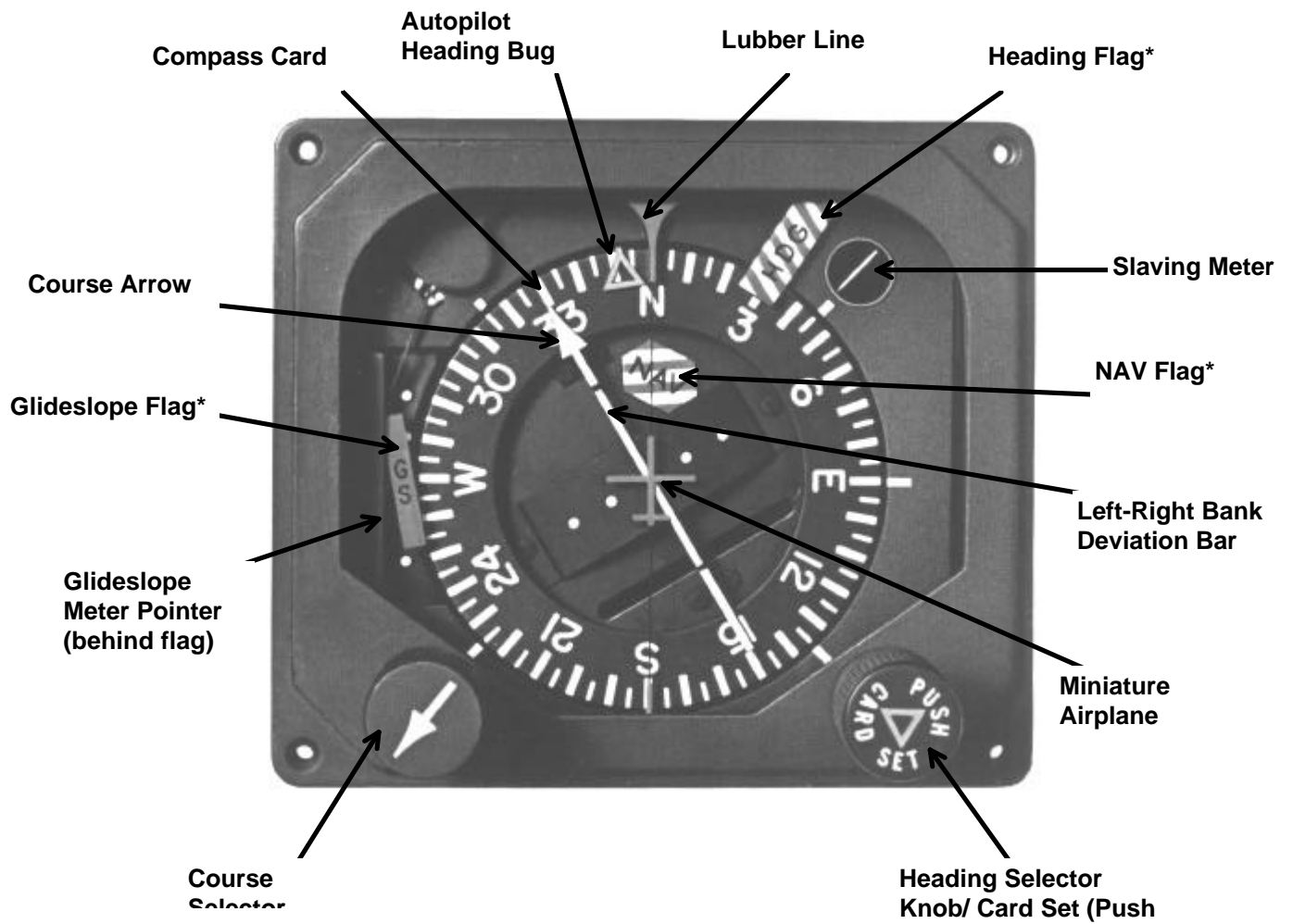

NSD-360A

NSD-360A AND OTHER COMPASS SYSTEMS

The Century 41 autopilot may be optionally equipped with the Century Flight Systems NSD-360A or other approved ARINC compass systems. The explanation which follows will be based on the NSD-360A; however, the principles will apply equally to the compass systems of other manufacturers provided the differences in design, features and concepts are ascertained and allowed for, such as slaving, knob location, size, etc.

The NSD-360A (Navigation Situation Display) is an integrated HSI instrument combining an air driven gyro and an electrically servo heading card with VOR/Localizer and Glideslope information. The NSD-360A has an optional slaving feature that requires initial heading setting on start-up. Subsequent resetting of the heading card, required manually on non-slaved versions, is automatically accomplished.

The NSD-360A has incorporated a heading warning flag to warn of loss of either air or electric power. Appearance of the flag during flight should be sufficient grounds to question the validity of displayed heading. In slaved versions, the slaving meter should oscillate about 45° point to show that the slaving circuits are accomplishing motionless or either vertical or horizontal for an extended period (two minutes) in level flight, the heading should be manually set using the magnetic compass and the performance of the heading card observed. If slaving difficulties are encountered, set the slaving mode switch to SL 2 or free gyro. In free gyro mode, the instrument must be periodically reset to manually counteract the effects of gyro precession.

NOTE

Do not set heading card when turning as the magnetic compass and magnetic flux detectors in slaved systems are not reliable references when the aircraft is banked.

NSD-360A CONTROLS

The heading selector/card set is used to move the heading bug relative to the heading card. It is also used to set the heading card to the aircraft heading by pushing in and rotating card. When setting has been accomplished the knob is released. The heading selector should not be pushed in when setting the heading bug.



The course selector knob is used to adjust the autopilot course selector arrow to the desired course. Selection of the autopilot course automatically sets the internal VOR resolver to the identical VOR radial. Readout of VOR left-right information is made by observing the center segment of the course arrow.

DISPLAYS

NSD-360A VOR/Localizer left-right deviation is displayed by the center segment of the autopilot radio course arrow. Note that the airplane in the center of the instrument display gives a pictorial representation of the Navigation Situation. In the illustration, the aircraft is approaching the desired radial at about 20° intercept. When operating in the VOR mode, the display always gives the correct display if the heading card is matched to the magnetic heading. When operating in the localizer mode, the course arrow should be placed on the INBOUND front course heading. The display will then be correct for either front course or back course.

During Back Course Approaches, the display will be inverted and the tail of the course arrow will indicate the back course heading. The Lift-Right needle sensing will require turns toward the needle for course centerline.

“TO” FLAG - “FROM” FLAG

The to and from flags point in the direction of the VOR Station. To or from is pictorially represented.

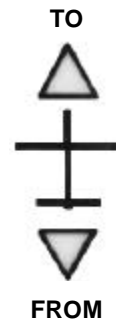

NAV WARNING FLAG

The NAV warning flag will appear if the signal being received is not suitable for NAVigation.

In the NSD-360A, separate “NAV” and “TO-FROM” meter movements are used. Good navigation data will be indicated in both VOR and Localizer mode by absence of the NAV Flag. In the localizer mode the “TO-FROM” arrows may remain out of view (depending on NAV converter design).

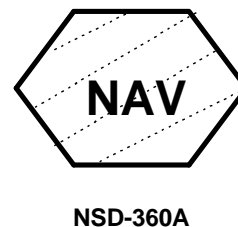

GLIDESLOPE

The glideslope meter on the left side of the instrument displays conventional glideslope information - location of glideslope centerline is pictorially represented.

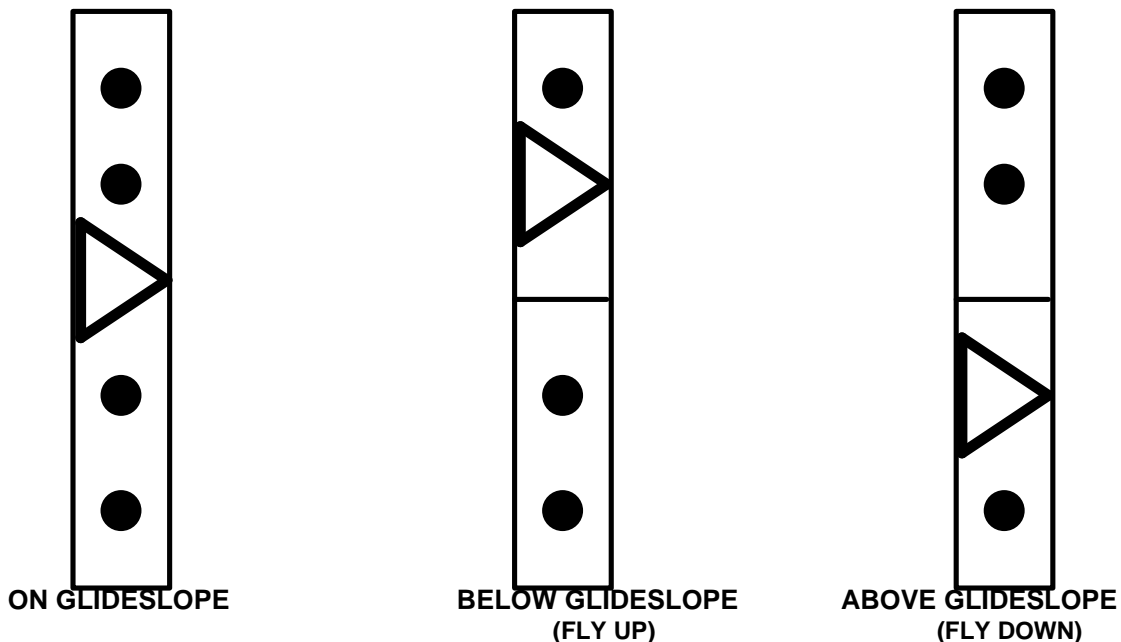

The Glideslope Flag is on the left side of the instrument. It is arranged so that it will obstruct view of the glideslope meter if a glideslope signal is not available or is unsuitable for guidance.

IMPORTANT NOTICE

Because the NSD-306A incorporates an integrated course/left-right display and OBS resolver, the use of a NAV-1/NAV-2 switch is not recommended with the NSD-360A for left-right information.

The Century 41 requires left-right data and course error data that is related to the actually heading of the aircraft. The use of a NAV-1/NAV-2 selector switch would involve complex operational techniques that would add confusion in moments of stress and its installation is therefore not encouraged.

CENTURY 41 OPERATING TECHNIQUES

In the pages that follow, we have included techniques for :

Localizer Approaches
Glideslope Arming & Coupling } ILS

Localizer Back Course

VOR Approaches



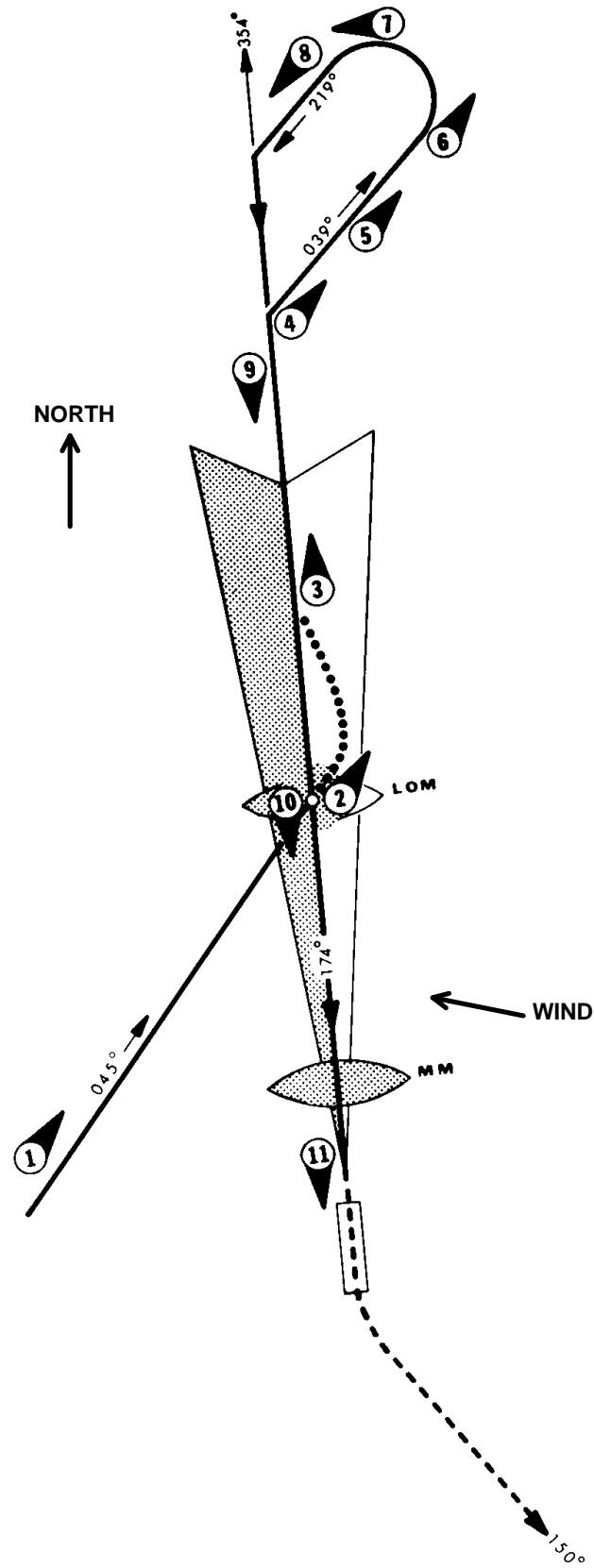

VOR Navigation

The photographs depict the Navigation Situation at the indicated position as seen on the NSD-360A. The techniques are equally applicable to other Integrated Compass Systems (PN101, KPI-550, Etc.). The techniques are to the 52D254 DG, provided it is understood that the DG Heading Bug and OBS must be set separately to achieve the desired results.



LOCALIZER (LOC) APPROACH



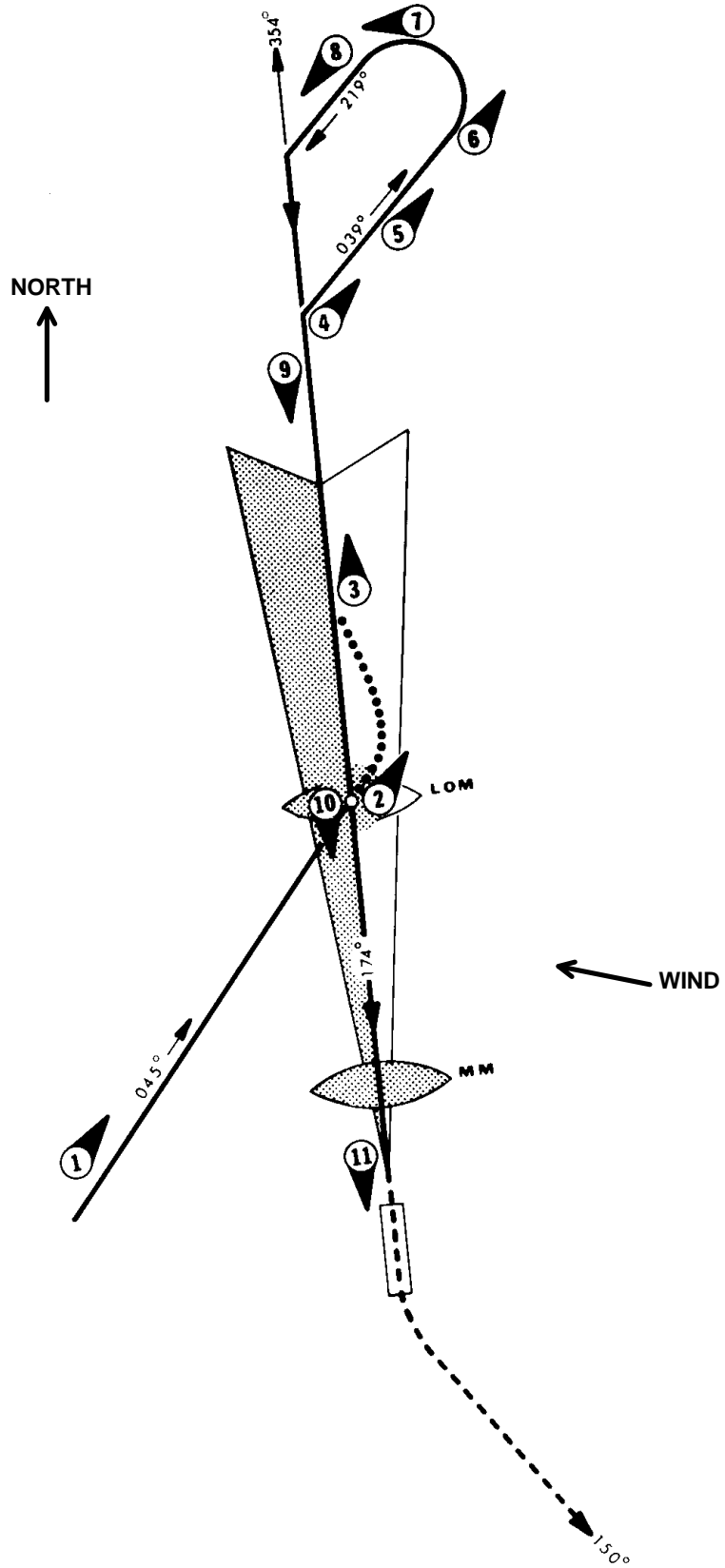

Localizer (LOC) Approach

PSN	NSD-360A	MODE	REMARKS
1		HDG ALT OR ATT	The localizer or ILS approach begins with a transition from the enroute structure to the outer compass locator (LOM). The HDG mode and HDG Bug is used by the pilot to select the desired heading. Aircraft altitude or rate of descent is controlled using ALT, ATT, the Pitch Data Modifier or Pitch Sync. The Inbound Front Course direction is selected with the course arrow.
2		REV ALT OR ATT	Upon reaching the (LOM), press the REV Button. System will intercept and track Outbound. Note: This is a good time to begin reducing speed for the approach.
3		REV ALT OR ATT	Altitude appropriate to this phase of the approach should be controlled using ALT and/or ATT as necessary. The procedure turn outbound heading may be pre-selected using the heading bug.
4		HDG ALT OR ATT	Press the HDG Button to begin procedure turn.
5		HDG ALT OR ALT	Proceed outbound in procedure turn until sufficient time has elapsed to assure proper re-interception.



LOCALIZER (LOC) APPROACH (Cont.)

Localizer (LOC) Approach (Cont.)

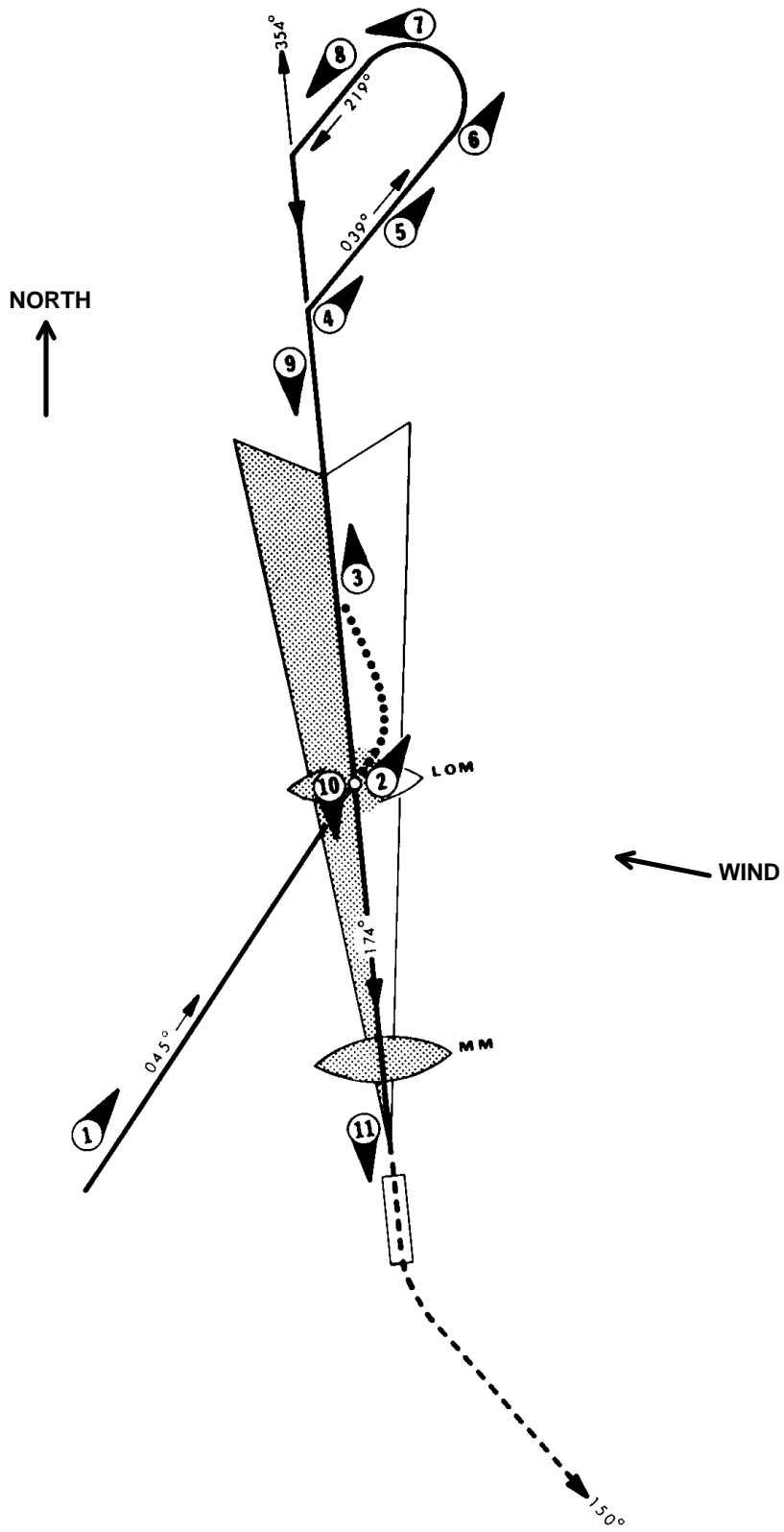

PSN	NSD-360A	MODE	REMARKS
6		HDG ALT OR ATT	Lead aircraft through procedure turn by moving the heading bug initially about three-fourths of the way around the card in the desired direction of the turn.
7		HDG ALT OR ATT	As the aircraft turns, move the heading bug to the desired intercept heading. In this case the pilot has selected 199° for a selected angle intercept.
8		APR ALT OR ATT	If a 45° intercept is desired press APR Button...system will automatically execute 45° (approximate) intercept.
8A		HDG APR ALT OR ATT	Alternate - If intercept angle other than 45° is desired, set heading bug to desired intercept heading. Press both HDG and APR buttons simultaneously. System will remain in HDG until aircraft turns on course, then automatically switch to APR as indicated by extinguishing the HDG Annunciator. Note: The selected angle intercept is particularly useful if being vectored to the final approach course.

9		APR ALT OR GS	After intercept, system will correct for crosswind, adjust its internal radio authority and limit bank angles. Aircraft altitude should be controlled as necessary for the approach using ALT and ATT. Glideslope arming and interception will be automatic. Missed approach heading may now be programmed.
---	---	------------------------	---



LOCALIZER (LOC) APPROACH (Cont.)

Localizer (LOC) Approach (Cont.)



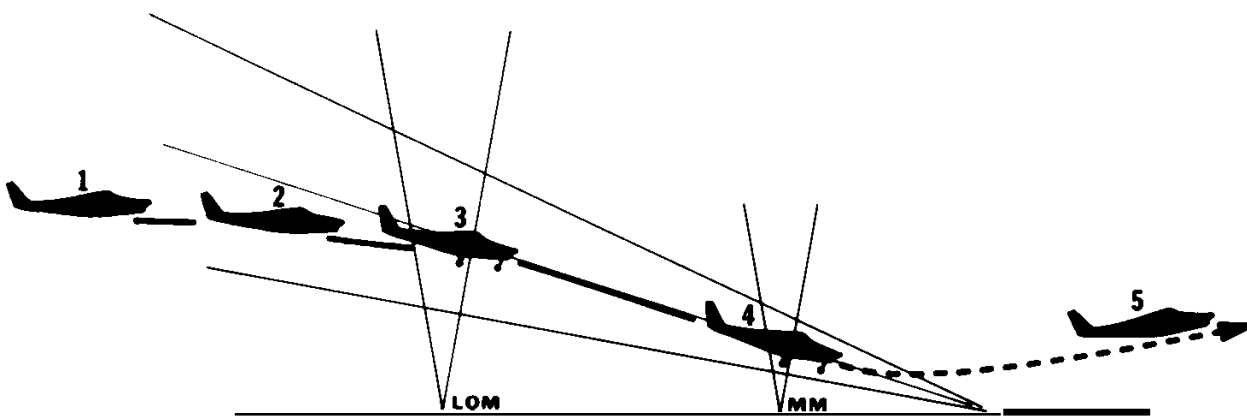

10		APR GS	As the glideslope is intercepted, capture is indicated by extinguishing ALT or ATT with only GS remaining illuminated.
11		HDG GA	<p>If missed approach is required, the following sequence is typical, see AFM Supplement for details in specific model aircraft.</p> <ol style="list-style-type: none"> 1. Press GA. 2. Add Power. 3. Check for positive rate of climb. 4. Retract gear and flaps. 5. Press HDG to turn to required heading. 6. Adjust climb as desired using Pitch Sync or Pitch Modifier.

NOTE: When GA is pressed, lateral modes remain as programmed and autopilot remains engaged.



GLIDESLOPE (GS) AUTOMATIC ARM AND COUPLE

Glideslope (GS) Automatic Arm and Couple



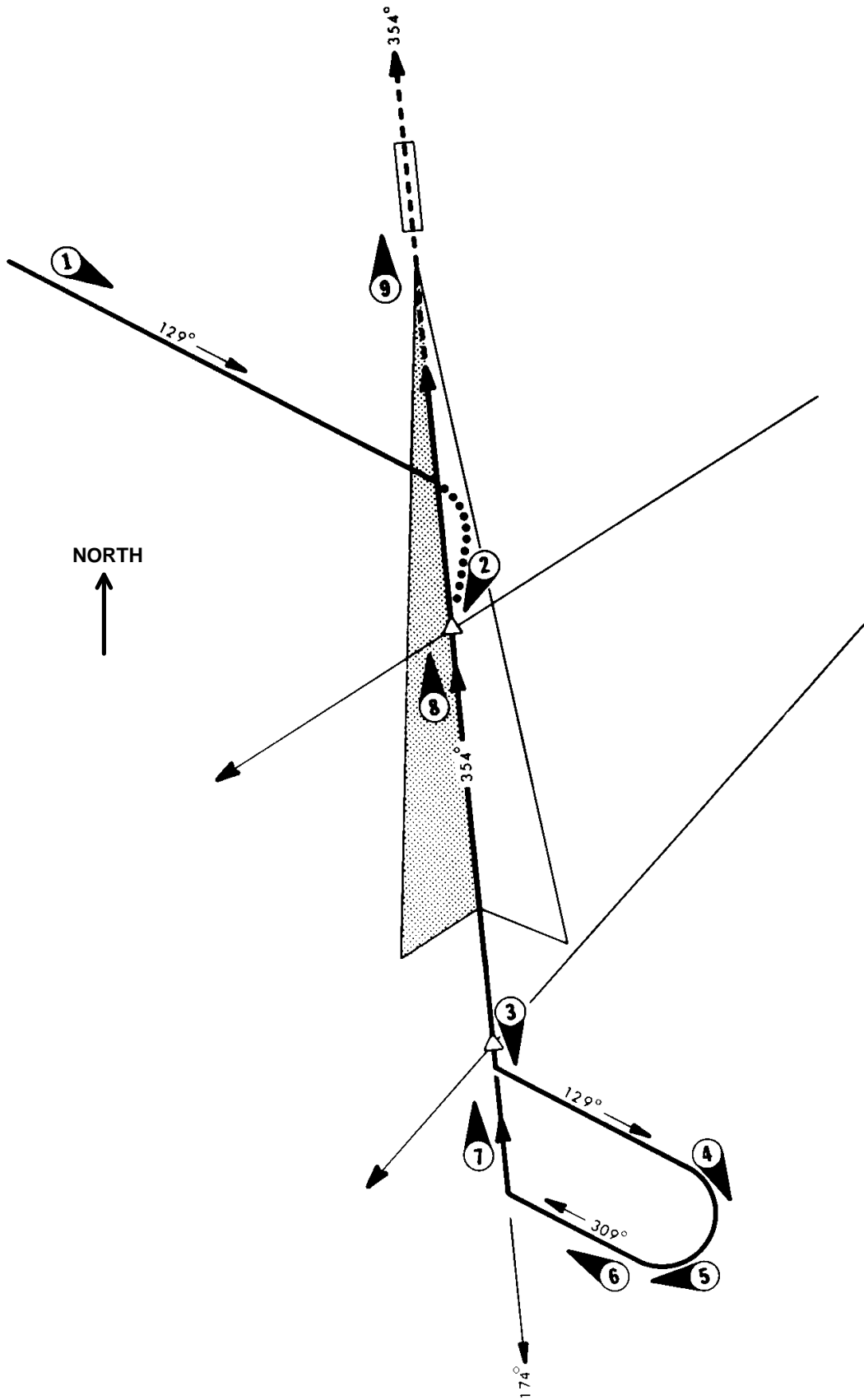

PSN	NSD-360A	MODE	REMARKS
1		APR ALT OR ATT	The typical glideslope portion of an ILS begins with the aircraft maintaining altitude for some distance prior to reaching glideslope interception. However, automatic capture will occur if the aircraft is being flown in ATT mode downward to the glideslope.
2		APR ALT OR ATT	The Century 41 recognizes the following conditions: 1. Tuned to Localizer Frequency. 2. Localizer less than 80% scale. 3. Valid Localizer signal (no flag). 4. Valid Glideslope signal (no flag). 5. APR mode selected.
3		APR GS	When interception occurs, the Glideslope Coupler will couple as indicated by the ALT or ATT annunciator extinguishing while the GS annunciator remains on. Lower the gear and flaps as indicated in the AFM Supplement. Note: Monitor steering horizon, and course guidance throughout the approach.
4		APR GA	Upon reaching DH, complete approach or conduct normal GA sequence.
5		HDG GA	As safe altitude is reached, press HDG button for missed approach heading. Note: Pressing GA Button disconnects Glideslope Coupler but does not reprogram lateral modes or disconnect autopilot.

NOTE: In order to prevent Automatic Glideslope Arm and Coupling (e.g. when holding on the localizer) use the NAV mode instead of APR.



LOCALIZER BACK COURSE (LOC BC)



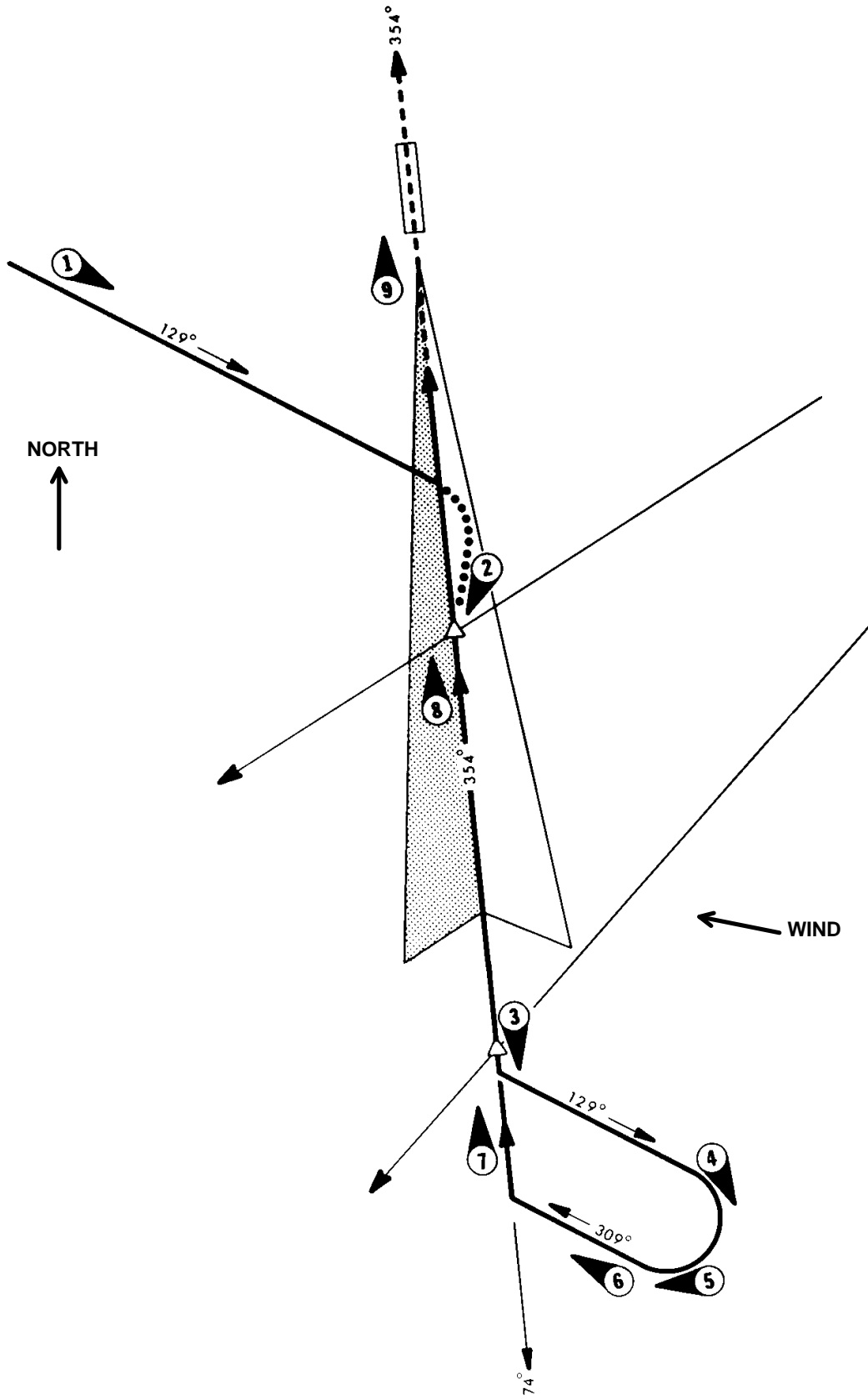

Localizer Back Course (LOC BC)

PSN	NSD-360A	MODE	REMARKS
1		HDG ALT OR ATT	The LOC (BC) back course approach begins with a transition from enroute structure to an intercept with the back course Outbound. The Inbound Front Course is set on the course arrow, and a 45° intercept to the course is achieved by pressing the NAV button to fly the back course Outbound. Note: The set up for this example is the same as flying the front course across the airport and continuing outbound.
1A		HDG NAV ALT OR ATT	Alternate - If an intercept angle other than 45° is desired, press HDG and NAV simultaneously - the system will follow heading bug until the intercept turn begins, then automatically switch to APR mode and extinguish the HDG annunciator.
2		NAV ALT OR ATT	As outbound tracking begins, select outbound procedure turn heading with heading bug. Altitude should be controlled using ALT or ATT as appropriate for this phase of the approach.
3		HDG ALT OR ATT	When outbound procedure turn heading is desired, press HDG Button, fly outbound for sufficient time to permit re-interception.
4		HDG ALT OR ATT	Lead aircraft through procedure turn initially by turning heading bug approximately three/fourths distance around the card in the desired direction of turn.



LOCALIZER BACK COURSE (LOC BC) (Cont)



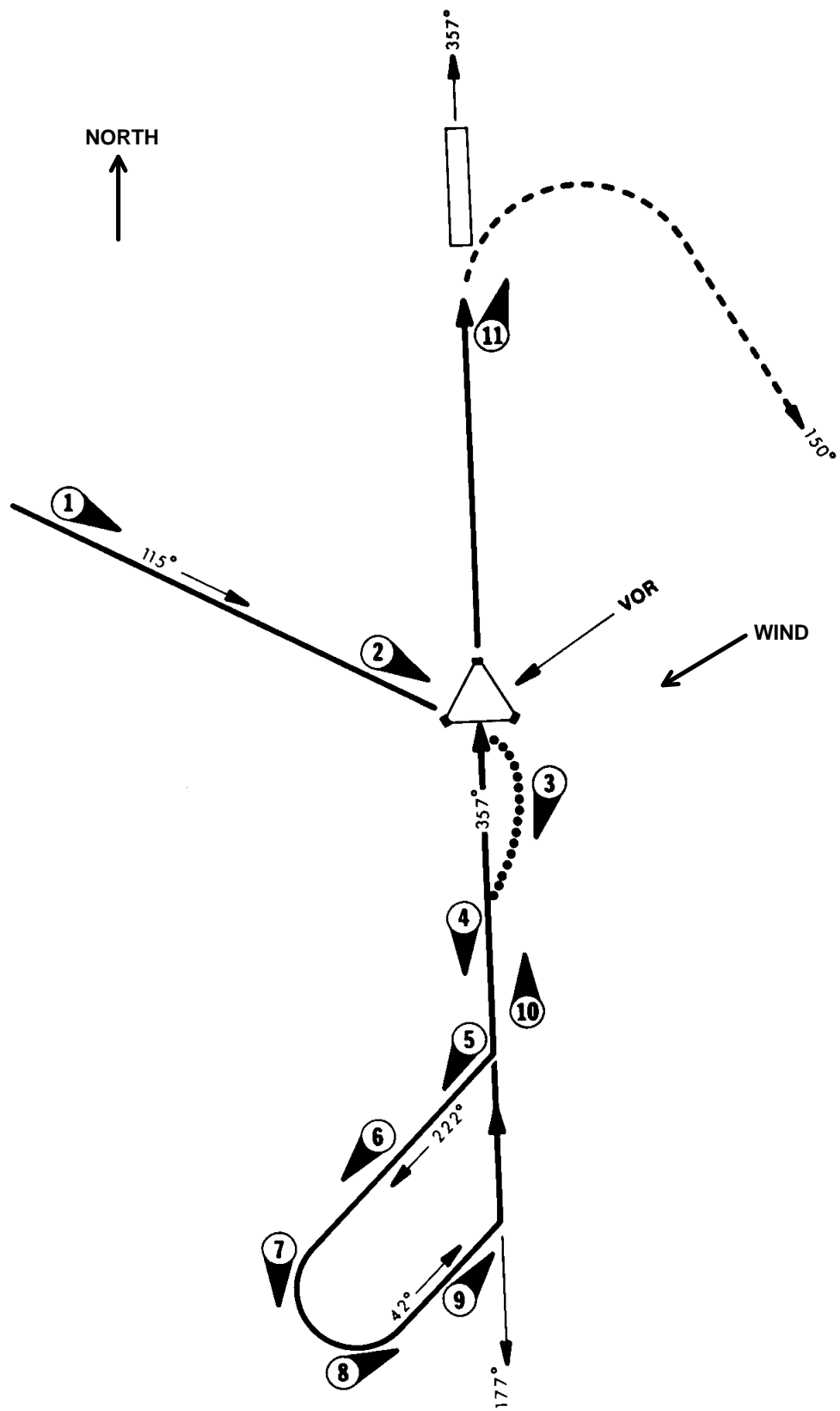

Localizer Back Course (LOC BC) (Cont.)

PSN	NSD-360A	MODE	REMARKS
5		HDG ALT OR ATT	As aircraft turns, set heading bug to inbound procedure turn heading.
6		HDG ALT OR ATT	As aircraft nears inbound procedure turn heading, press REV button for 45° intercept or use the selected angle intercept.
7		REV ALT OR ATT	After intercept, system will correct for crosswind, adjust its internal radio authority and limit bank angles. Heading bug may be aligned with lubber line or set to missed approach heading. When final approach or step down fix is reached, control rate of descent with ATT, Pitch Modifier and/or Pitch Sync.
8		REV ATT	Control altitude and rate of descent with ALT, ATT, Pitch Modifier and/or Pitch Sync.
9		REV GA	For missed approach, conduct normal Go-around sequence.



VOR APPROACH



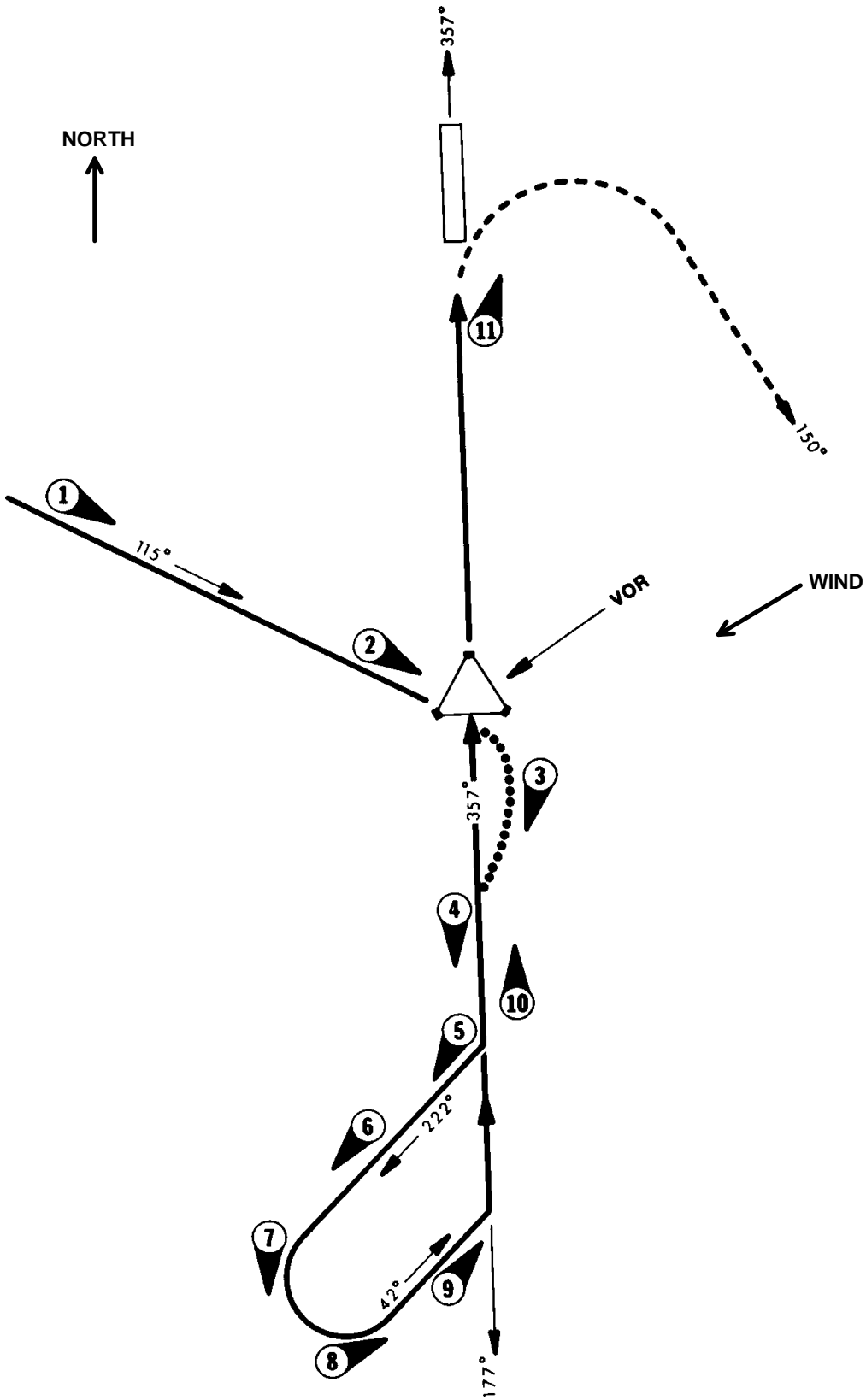

VOR Approach

PSN	NSD-360A	MODE	REMARKS
1		NAV ALT OR ATT	The VOR approach usually begins from an enroute situation. If ATC requires a descent during this phase, ATT would be used instead of ALT.
2		HDG ALT OR ATT	As the VOR is neared, match the heading bug to either the course or the lubber line and press HDG Button. Course arrow may now be set for inbound intermediate course segment.
3		REV ALT OR ATT	As the VOR is crossed, press the REV Button to fly the selected course outbound. Should a lower altitude be desired, ATT should be pressed and the aircraft flown to the desired Altitude.
4		REV ALT OR ATT	When the desired altitude is reached, press ALT; the procedure turn outbound HDG is pre-selected with the heading bug.
5		HDG ALT OR ATT	Pressing the HDG Button will cause the aircraft to turn to the selected outbound procedure turn heading.



VOR APPROACH (Cont.)

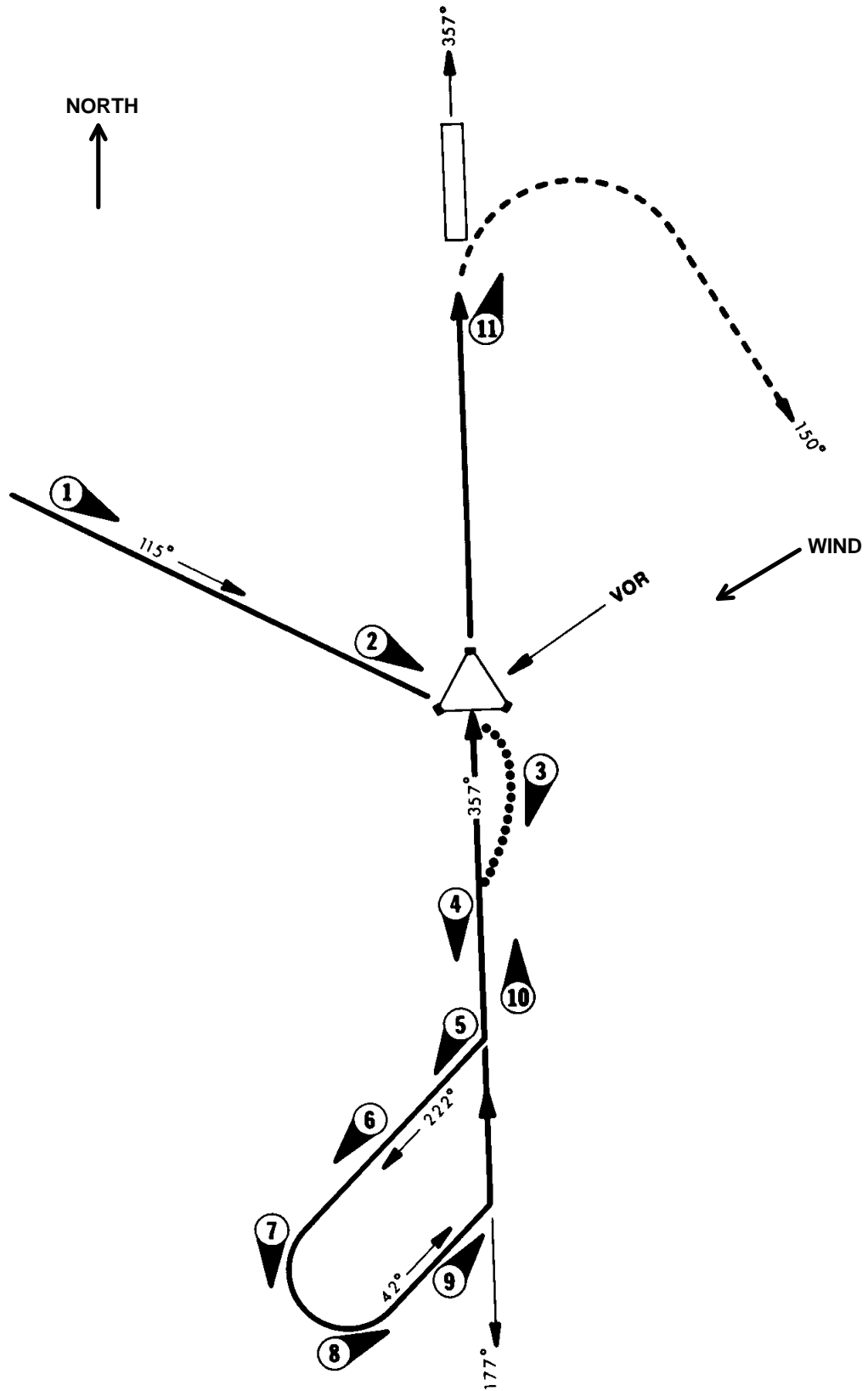

VOR Approach (Cont.)

PSN	NSD-360A	MODE	REMARKS
6		HDG ALT OR ATT	Proceed outbound until sufficient time has elapsed to assure proper re-interception.
7		HDG ALT OR ATT	Lead aircraft through procedure turn by moving the heading bug initially about three-fourths of the way around the card in the desired direction of the turn.
8		HDG ALT OR ATT	As the aircraft turns, move the heading bug to the desired intercept heading.
9		APR ALT OR ATT	Press APR Button; system will automatically execute 45° (approximate) intercept.
9A		HDG APR ALT	Alternate - If intercept angle other than 45° is desired, set heading but to desired intercept heading. Press both HDG and APR simultaneously. System will remain in HDG until needle reaches one-half scale and then automatically switch to APR as indicated by extinguishing the HDG annunciator.



VOR APPROACH (Cont.)



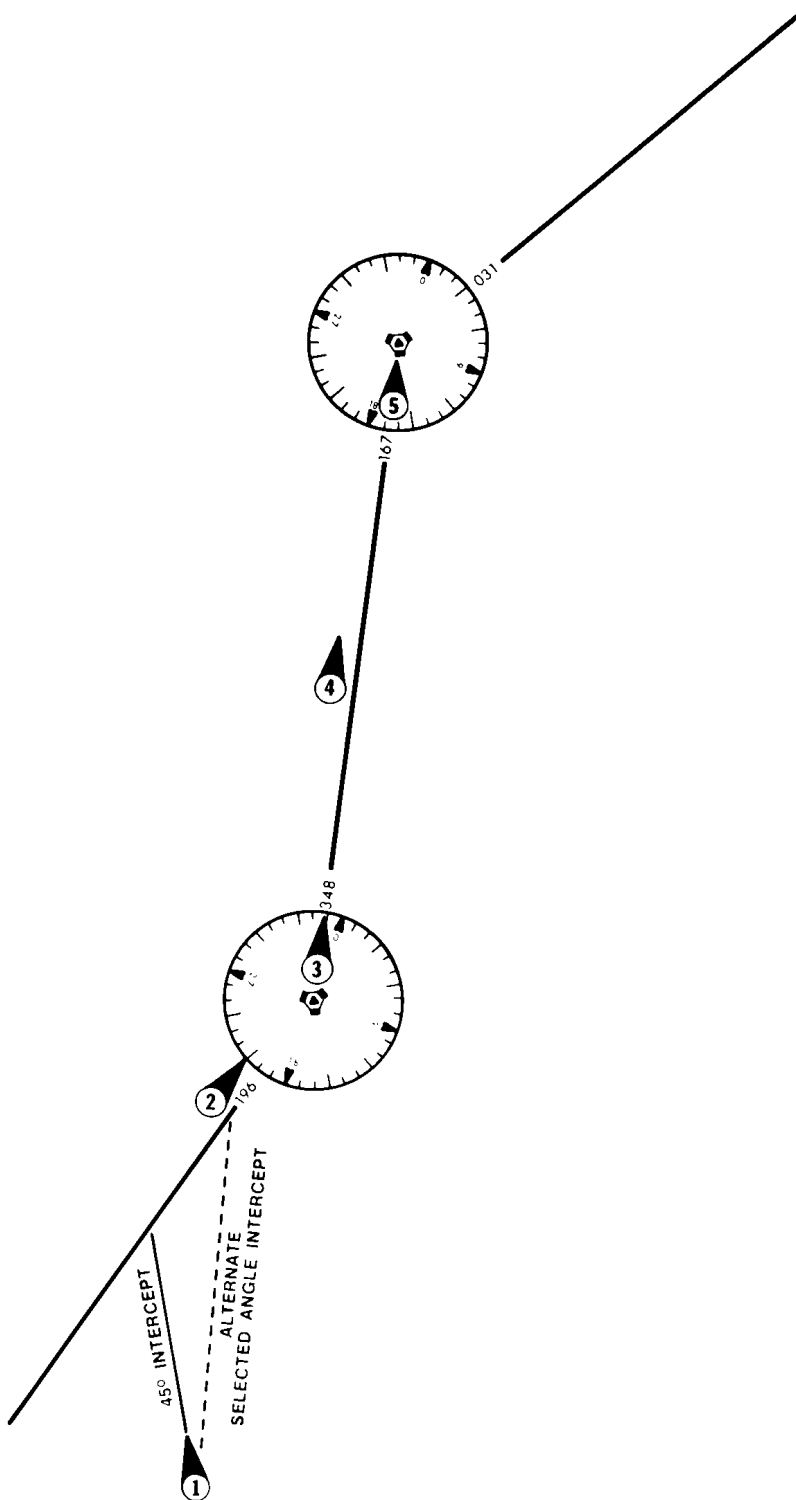

VOR APPROACH (Cont.)

PSN	NSD-360A	MODE	REMARKS
10		APR ATT	After intercept, system will correct for crosswind, adjust its internal radio authority and limit bank angles. Aircraft altitude should be controlled as appropriate for the approach by the use of ALT, ATT, and Pitch Data Modifier or Pitch Sync. Should a course change be required for the final approach segment, simply move the course selector to the new course at the VOR. Missed approach heading may be programmed with the HDG bug.
11		HDG GA	For missed approach, conduct normal GA sequence.



VOR NAVIGATION

VOR NAVIGATION

PSN	NSD-360A	MODE	REMARKS
1		NAV ALT	Forty-five degree intercept to a selected radial is automatically accomplished by setting the course arrow/OBS to the desired VOR course and pressing the NAV button on the Programmer.
1A		HDG NAV ALT	Alternate - If an intercept angle of other than 45° is desired, select the desired course arrow/OBS and the desired intercept heading with the Heading Bug. Press HDG and NAV simultaneously. The system will remain in HDG mode until aircraft begins on course turn and then switch automatically to NAV.
2		NAV ALT	After intercept, system will correct for crosswind, adjust its internal radio authority and limit bank angles.
3		NAV ALT	If a course change is required at the VOR, simply reposition the course arrow/OBS to the NAV course. If change is small, (less than 45°), system will remain in bank limiting. If change is large, system will re-cycle as in PSN 2.
4		NAV ALT	Station switching is accomplished by re-channeling the NAV receiver to the station ahead and repositioning the course arrow/OBS to the new course. Note: If desired, station change may be made by setting Heading Bug, press HDG and then pressing NAV Button after setting course arrow/OBS, system recycles as in PSN 2 if system is reprogrammed.

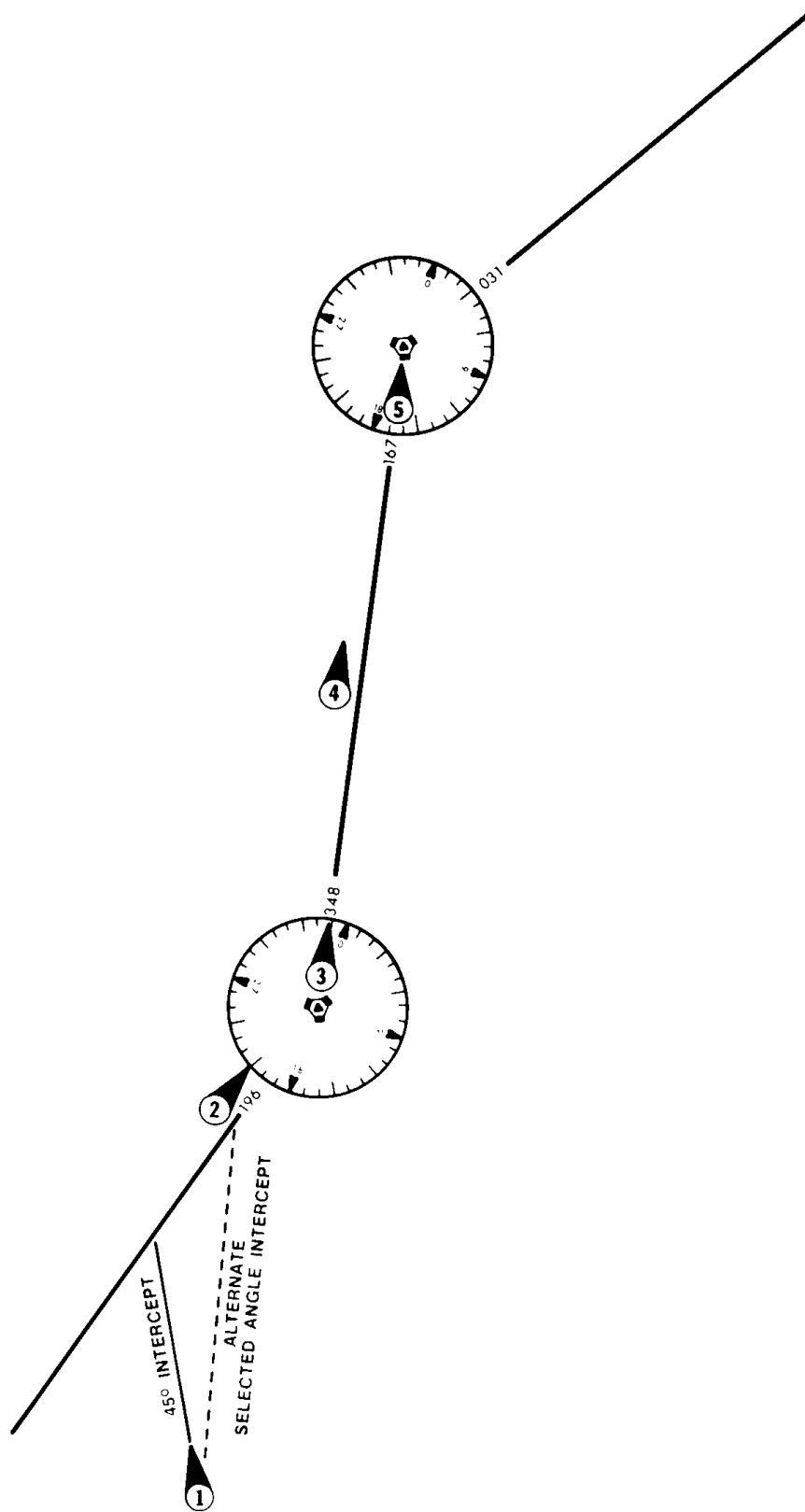

VOR NAVIGATION (Cont.)

VOR NAVIGATION (Cont.)

PSN	NSD-360A	MODE	REMARKS
5		HDG NAV ALT	<p>The selected angle intercept feature may be used for course changes at VOR's if desired. When near the VOR (5 nm, max), match the heading bug to the lubber line and press HDG button. Set new course with the course arrow/OBS. Press HDG and NAV Buttons simultaneously. When the new radial is intercepted, system will automatically switch to NAV and acquire the new course.</p>

MAINTENANCE

The **Century 41** has been designed and manufactured to render reliable service; however, some of the system components will require a regular inspection and service. It is important that agencies selected for service are properly qualified and equipped to render service on the Century 41.

We have listed several items below to assist you in monitoring your system maintenance.

1. **Gyro Filters** - The gyros used with the Century 41 are precision devices whose performance and service life are in part dependent upon the quality of the air supply. Poor air quality can significantly reduce gyro life (to hours) and performance by contaminating bearings. Regular filter maintenance is good investment.
2. **Aircraft Static Systems** - Air leaks and water entrapment can significantly affect altitude hold performance. Static System Maintenance and checks help not only the AFCS, but assure proper function of static instruments. Altitude Hold units used by Century Flight Systems should NOT be disconnected during static system checks as they are designed to withstand such tests without damage.
3. Periodic inspection and maintenance is recommended for those items of the autopilot which attach to the aircraft control systems. During normal inspection is a good time to make these simple checks on the autopilot.
 - A. Inspect the bridle cable on the Pitch, Roll and Yaw Servos for:
 1. Condition.
 2. Tension - feels equally tight as main cable.
 3. Freedom - move controls through travel.
 - B. Inspect bridle cable clamps for:
 1. Obstruction.
 2. Bolt Torque - 55 ± 5 inch pounds of torque. Note: This higher than normal torque is FAA approved and required.
 3. Gap between clamp halves - .005" minimum, assures that cables are under clamping pressure.
 - C. Inspect Trim Capstans for:
 1. Evidence of wear.
 2. The clutch should slip instead of cable on capstan if overpowered.
 - D. Inspect Trim Cables for:
 1. Fraying.
 2. Proper tension (high end of spec is usually best).
 3. Freedom of travel

EMERGENCY OPERATION

Appearance of HDG Flag:

1. Check air supply gauge (vac or pressure) for adequate air supply (4 in. Hg. min.).
2. Check NSD-360A circuit breaker.
3. Observe display for proper operation.

To disable heading card - pull circuit breaker and use magnetic compass for directional data. Note: If heading card is not operational, autopilot should not be used.

With card disabled - VOR, Localizer and Glideslope displays are still functional; use card set to rotate card to aircraft heading for correct picture.

Slaving Failure - (i.e. failure to self-correct for gyro drift):

1. Check slave switch (if installed) for SL-1 PSN.
2. Check for HDG Flag.
3. Check NSD circuit breaker.
4. Reset heading card while observing slaving meter.
5. Select slaving amplifier No. 2 (SL2) if available.
6. Reset heading card while checking slaving meter.
7. Switch to free gyro and periodically set card as unslaved gyro.

NOTE

If the optional RMI feature is installed, it is inoperative in the SL 2 position.

PRODUCT IMPROVEMENTS

Century Flight Systems maintains a policy of constant product improvement. Many times these products improvements are made available on the retrofit basis to owners of earlier systems. In most cases, retrofit and upgrading is available at moderate cost through your Century Flight Systems Distributor. We must, because of practical considerations, state that we reserve the right to make changes in product specifications and prices without incurring obligations.

May we suggest that you ask your installer to enter this significant data in your Operator's Manual for easy reference:

AK NO. _____ System S/N _____ Date Installed _____

Installed by: _____

Major component part numbers and serial numbers

Controller/Flight Computer P/N _____

S/N _____

Compass System, P/N _____

Remarks (Special Features) _____

Registration of your system for warranty purposes will provide us with basic data on your system which we will use to make you aware of product improvements.

Should you sell you aircraft, may we ask you to advise the new owner of our continuing interest and ask him to drop us a note containing the above data so we may update our records.

Effective: July 4, 1975

LIMITED WARRANTY CENTURY FLIGHT SYSTEMS
AUTOPILOT

Each new Century Flight Systems Autopilot is warranted by the manufacturer to be free from defects in material and workmanship under normal use, subject to the following conditions:

1. Century Flight Systems will through its designated service facilities at its option either repair or replace new components which, shall within (12 months after date of installation, be found, to Century Flight Systems satisfaction, to have been defective in material or workmanship under normal use.
2. The warranty registration must be signed and returned to Century Flight Systems within ten days of equipment installation date. In the event that the registration card is not returned within this time, the date of shipment from the factory will be deemed to be the installation date.
3. This warranty will not apply to any product which has been installed, repaired or altered in any way whatsoever in Century Flight Systems opinion to adversely affect its performance or reliability, or which has been subject to misuse, contamination, negligence, or accident.
4. Cost of transportation, removal or reinstallation are at the option of Century Flight Systems.
5. This is Century Flight Systems sole express warranty with respect to the goods supplied herein. CENTURY FLIGHT SYSTEMS MAKES NO OTHER EXPRESS WARRANTY OF ANY KIND WHATSOEVER. CENTURY FLIGHT SYSTEMS EMPLOYEES MAY HAVE MADE ORAL STATEMENTS ABOUT THE PRODUCTS DESCRIBED IN THIS CONTRACT. SUCH STATEMENTS DO NOT CONSTITUTE WARRANTIES, SHALL NOT BE RELIED UPON BY THE CUSTOMER, AND ARE NOT PART OF THE SALE CONTRACT.
6. THE DURATION OF ANY IMPLIED WARRANTY, AND OF ALL WARRANTIES OF MERCHANTABILITY AND FITNESS FOR A PARTICULAR PURPOSE, SHALL BE LIMITED TO (12) MONTHS COMMENCING AT DATE OF INSTALLATION TO THE FULL EXTENT PERMITTED BY APPLICABLE LAW, CONSEQUENTIAL DAMAGE OR BREACH OF ANY WARRANTY ARE HEREBY DISCLAIMED AND EXCLUDED BY CENTURY FLIGHT SYSTEMS.

CENTURY FLIGHT SYSTEMS, INC.
P. O. Box 610
Mineral Wells, Texas
76068
January 1982